

MXFG2DSTR

3.5" MX G2 Naked LED Square Pinhole

ELECTRICAL DATA

LED Light Engine	System Wattage *	CCT / CRI	Delivered Lumens **	Lumens Per Watt
L0	11W	3000K / 82 CRI	700lm	70
L1	16W	3000K / 82 CRI	1000lm	63
L2	22W	3000K / 82 CRI	1150lm	58
L3	27W	3000K / 82 CRI	1600lm	62

*System Wattage include driver and LED Module consumption. **Delivered lumens will vary depending on trim, CCT, CRI, optic and ceiling thickness

FEATURES

- High center beam spot up to 24,500 CBCP
- Available optics: 12°, 24°, 36° or 50°

LED LIGHT ENGINE

- 92 CRI & 82 CRI in 2700K, 3000K, 3500K or 4100K with 2SDCM binning
- >50,000 hours L70 (rated life at 70% output)

ELECTRICAL SYSTEM

- Dedicated voltage options of 120V or 277V. Must be specified in catalog code.
- This product complies with IEEE C62.41 for surge endurance up to 2.5KV
- Additional surge protection recommended, damage from power surge is not covered by warranty

DIMMING

- 0-10V Dimming 1%
- Forward/reverse dimming 1% (120V only)
- EldoLED 0-10V 0.1% or 1%
- Lutron® LDE1 Hi-Lume 1% EcoSystem LED driver with Soft-on, Fade-to-Black dimming technology
- DMX512 RDM 0.1%

HOUSING

- Heavy duty galvanized 18 gauge steel frame
- Standard plaster frame accommodates 1/2" to 1-1/4" ceiling thickness
- Extended collar options available for ceilings up to 1-1/4" to 2-1/2" thick

TRIM SPECIFICATION

- A380 aluminum die-cast trims
- Durable powder coat available in multiple finishes

INSTALLATION

- Non-IC rated housings must be kept at a minimum of 3" away from insulation
- Fixture includes adjustable bar hangers (14"-24") for wood joist or t-bar ceiling installations
- Bar hangers can be installed in either direction
- Maximum ambient temperature: 95°F (35°C)

EMERGENCY BACKUP

- Remote test switch included
- External battery operates LED load at a minimum of 400lm to 650lm for 90 minutes, depending on backup wattage
- Servicing requires above ceiling access

LISTING / WARRANTY

- 5-Year Intense LED Limited Warranty
- ETL listed to US and Canadian standards for damp locations



JOB NAME		CATALOG NUMBER	
NOTES		TYPE	

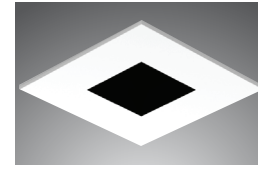

MXTFG2-STRD306
(1-1/2" Regress)

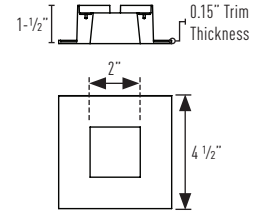

Available Trim Finishes



Housing dimensions on Page 2

Related Products

For Adjustable, Wall Wash and other Trim options see standard MX Downlight Products

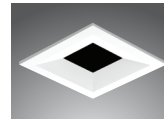

See [MXG2DSTR](#) for more downlight trim options

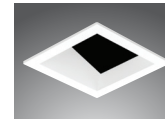

See [MXG2ASTR](#) for adjustable alternative

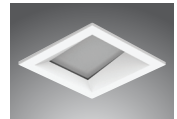

See [MXG2WSTR](#) for wall alternative

Housing Part Number (Example: MXFG2DSTR-NCL2DELV)

Housing	Installation Type	Ceiling Thickness	Wattage	Dimming	Voltage	Options
MXFG2DSTR	-NC (Non-IC)	blank (1/2" to 1-1/4")	L0 (11W)	blank (Non-Dimming)	blank (120V)	EM7 ⁴ (7W Emergency Backup IOTA Part #ILB-CP07-A) EM12 ^{4,5} (12W Emergency Backup IOTA Part #ILB-CP12-A)
			L1 (16W)	(Phase Dimming)		
		L2 (22W)	D101 (0-10V Dimming 1%)			
		L3 (27W)	ED10V1 ² (eldoLED 0-10V 1%)			
			ED10V01 ² (eldoLED 0-10V 0.1%)			
	LUT ³ (Lutron® LDE1 EcoSystem 1%)					
		EC2 (1-1/4" to 2-1/2")				

Trim Part Number (Example: MXTFG2-STRD306WL13024)

Trim	Finish	Wattage	CCT / CRI	Optic
MXTFG2-STRD306 (1-1/2" Regress)	B (Black)	L0 (11W)	27 (2700K / 82 CRI)	12 (12° SP)
		L1 (16W)	279 (2700K / 92 CRI)	24 (24° NFL)
	W (White)	L2 (22W)	30 (3000K / 82 CRI)	36 (36° FL)
		L3 (27W)	309 (3000K / 92 CRI)	50 (50° WFL)
			35 (3500K / 82 CRI)	
			359 (3500K / 92 CRI)	
		41 (4100K / 82 CRI)		
		419 (4100K / 92 CRI)		

Notes:

- Available in 120V only
- Not Available in L3
- Not available with L2 & L3
- Access above ceiling required
- Not available in L0
- Consult factory for lead times

Accessories

- LH47 (Accessory Holder, Black)
- LH47W (Accessory Holder, White)
- PFLMB-47 (Hex Louver, Black)
- PFL1-47 (Prismatic Spread Lens)
- PFL2-47 (Linear Spread Lens)
- PFL4-47 (Soft Focus Lens)

SPECIFICATION SHEET / M-July 19, 2025 4:04 PM P-1

INTENSE LIGHTING | 3340 E La Palma Ave, Anaheim, CA 92806 | tel 714 630-9877 | fax 714 630-9883

For Intense Lighting's limited product warranty, go to www.intenselighting.com. For a printed copy of the warranty, you may call 800 961-5321.

© 2025 Intense Lighting, LLC. All rights reserved. Note: This document is subject to change without notice.

MXFG2DSTR

3.5" MX G2 Naked LED Square Downlight

HOUSING DIMENSIONS

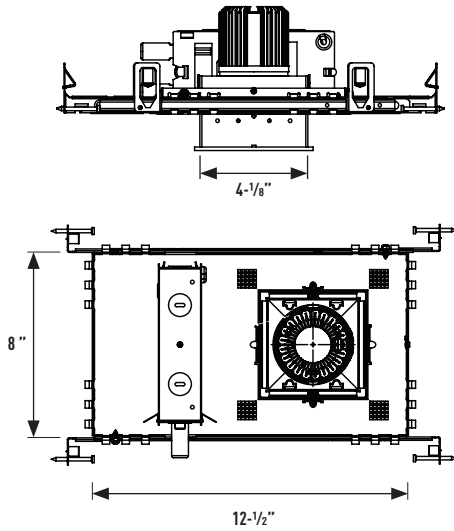

Adjustable Collar Height

Collar Type	Standard	EC2
Max Ceiling Thickness	1/2" to 1-1/4"	1-1/4" to 2-1/2"

JOB NAME	CATALOG NUMBER
NOTES	TYPE

L0-L1 Lumen Package

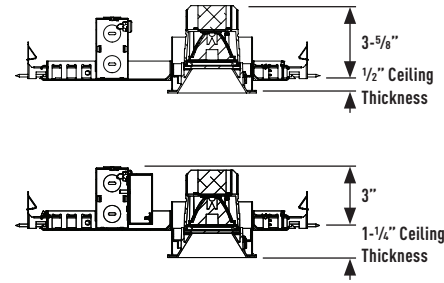

L2-L3 Lumen Package

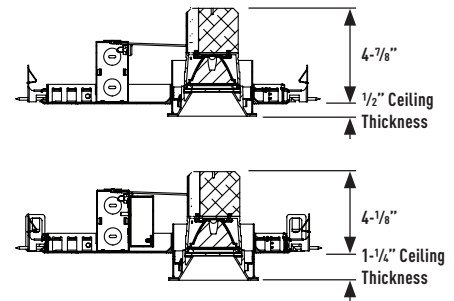

JOB NAME		CATALOG NUMBER	
NOTES		TYPE	

MXTFG2-STRD306L0

Report #: ILL-02122016-11.3 (12)
 ILL-02122016-10.3 (24)
 ILL-02162016-02.3 (36)
 ILL-02122016-06.3 (50)

MXTFG2-STRD306

Ceiling Thickness Multipliers:
 5/8" Thickness (x 1.00)
 1" Thickness (x 0.81)
 2" Thickness (x 0.62)

MXTFG2-STRR306

Ceiling Thickness Multipliers:
 5/8" Thickness (x 1.00)
 1" Thickness (x 0.83)
 2" Thickness (x 0.56)

CCT MULTIPLIERS:

	82 CRI	92 CRI
2700K	(x 0.93)	(x 0.76)
3000K	(x 1.00)	(x 0.87)
3500K	(x 1.00)	(x 0.87)
4100K	(x 1.00)	(x 0.87)

EMERGENCY MULTIPLIER:

7W Emergency (x 0.70)

12° Spot (12)

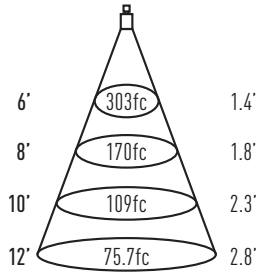

Watts: 11.3
 Lumens: 582
 LPW: 58
 CCT: 3000K

Candelas at Nadir

Degree	CBCP
0°	10895
5°	6333
15°	468
25°	43
35°	9
45°	2

24° Narrow Flood (24)

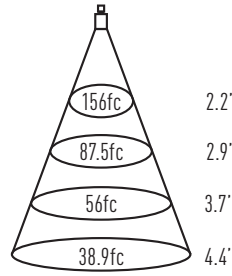

Watts: 11.3
 Lumens: 715
 LPW: 72
 CCT: 3000K

Candelas at Nadir

Degree	CBCP
0°	5600
5°	4829
15°	1002
25°	48
35°	4
45°	1

36° Flood (36)

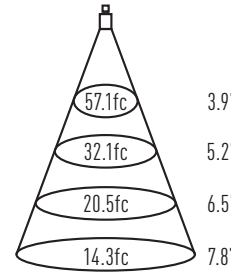

Watts: 11.3
 Lumens: 689
 LPW: 69
 CCT: 3000K

Candelas at Nadir

Degree	CBCP
0°	2054
5°	2020
15°	1333
25°	380
35°	55
45°	1

50° Wide Flood (50)

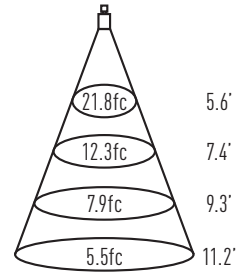

Watts: 11.3
 Lumens: 577
 LPW: 58
 CCT: 3000K

Candelas at Nadir

Degree	CBCP
0°	785
5°	785
15°	724
25°	383
35°	102
45°	4

MXTFG2-STRD306L1

Report #: ILL-02122016-11.2 (12)
 ILL-02122016-10.2 (24)
 ILL-02162016-02.2 (36)
 ILL-02122016-06.2 (50)

MXTFG2-STRD306

Ceiling Thickness Multipliers:
 5/8" Thickness (x 1.00)
 1" Thickness (x 0.81)
 2" Thickness (x 0.62)

MXTFG2-STRR306

Ceiling Thickness Multipliers:
 5/8" Thickness (x 1.00)
 1" Thickness (x 0.83)
 2" Thickness (x 0.56)

CCT MULTIPLIERS:

	82 CRI	92 CRI
2700K	(x 0.93)	(x 0.76)
3000K	(x 1.00)	(x 0.87)
3500K	(x 1.00)	(x 0.87)
4100K	(x 1.00)	(x 0.87)

EMERGENCY MULTIPLIER:

7W Emergency (x 0.50)
 12W Emergency (x 0.85)

12° Spot (12)

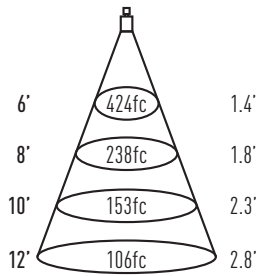

Watts: 15.4
 Lumens: 814
 LPW: 53
 CCT: 3000K

Candelas at Nadir

Degree	CBCP
0°	15253
5°	8866
15°	655
25°	60
35°	13
45°	2

24° Narrow Flood (24)

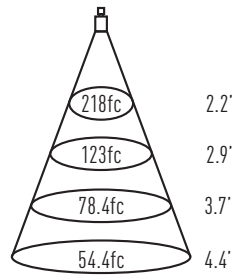

Watts: 15.4
 Lumens: 1001
 LPW: 65
 CCT: 3000K

Candelas at Nadir

Degree	CBCP
0°	7841
5°	6760
15°	1402
25°	67
35°	6
45°	1

36° Flood (36)

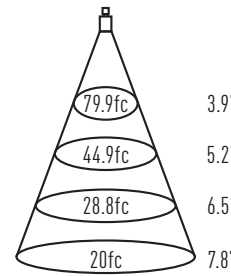

Watts: 15.4
 Lumens: 964
 LPW: 63
 CCT: 3000K

Candelas at Nadir

Degree	CBCP
0°	2876
5°	2828
15°	1867
25°	532
35°	77
45°	1

50° Wide Flood (50)

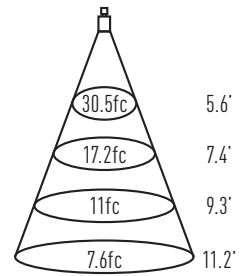

Watts: 15.4
 Lumens: 808
 LPW: 52
 CCT: 3000K

Candelas at Nadir

Degree	CBCP
0°	1099
5°	1099
15°	1013
25°	536
35°	143
45°	5

JOB NAME		CATALOG NUMBER	
NOTES		TYPE	

MXTFG2-STRD306L2

Report #: ILL-02122016-11.1 (12)
 ILL-02122016-10.1 (24)
 ILL-02162016-02.1 (36)
 ILL-02122016-06.1 (50)

MXTFG2-STRD306

Ceiling Thickness Multipliers:
 5/8" Thickness (x 1.00)
 1" Thickness (x 0.81)
 2" Thickness (x 0.62)

MXTFG2-STRR306

Ceiling Thickness Multipliers:
 5/8" Thickness (x 1.00)
 1" Thickness (x 0.83)
 2" Thickness (x 0.56)

CCT MULTIPLIERS:

	82 CRI	92 CRI
2700K	(x 0.93)	(x 0.76)
3000K	(x 1.00)	(x 0.87)
3500K	(x 1.00)	(x 0.87)
4100K	(x 1.00)	(x 0.87)

EMERGENCY MULTIPLIER:

7W Emergency (x 0.40)
 12W Emergency (x 0.68)

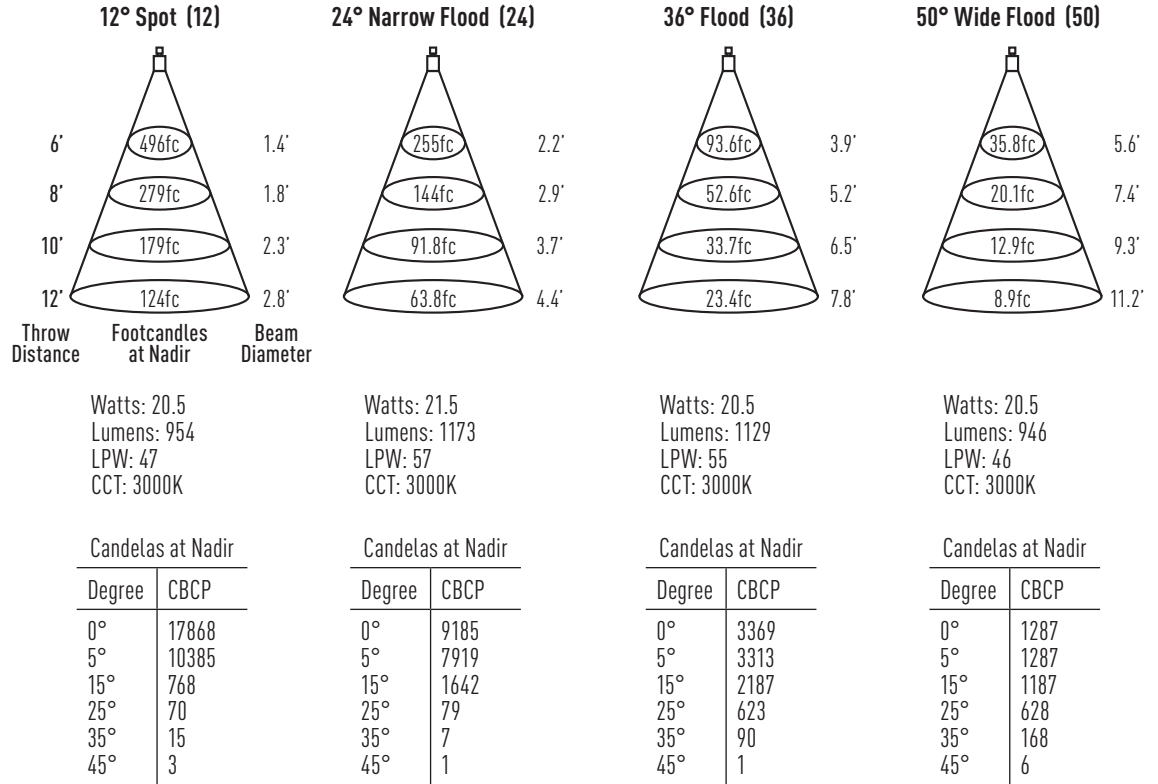

MXTFG2-STRD306L3

Report #: ILL-02122016-11 (12)
 ILL-02122016-10 (24)
 ILL-02162016-02 (36)
 ILL-02122016-06 (50)

MXTFG2-STRD306

Ceiling Thickness Multipliers:
 5/8" Thickness (x 1.00)
 1" Thickness (x 0.81)
 2" Thickness (x 0.62)

MXTFG2-STRR306

Ceiling Thickness Multipliers:
 5/8" Thickness (x 1.00)
 1" Thickness (x 0.83)
 2" Thickness (x 0.56)

CCT MULTIPLIERS:

	82 CRI	92 CRI
2700K	(x 0.93)	(x 0.76)
3000K	(x 1.00)	(x 0.87)
3500K	(x 1.00)	(x 0.87)
4100K	(x 1.00)	(x 0.87)

EMERGENCY MULTIPLIER:

7W Emergency (x 0.35)
 12W Emergency (x 0.59)

