

GC6DRREM

6" Gravity LED Downlight Cylinder With Remote Driver Enclosure

JOB NAME		CATALOG NUMBER	
NOTES		TYPE	

ELECTRICAL DATA: (Data Based On 3000K/82CRI Configuration)

LED Light Engine	Nominal Delivered Lumens *	System Wattage **	Efficacy	LED Light Engine	Nominal Delivered Lumens *	System Wattage **	Efficacy
L1	1000lm	9W	111 lm/W	L7	4000lm	34W	118 lm/W
L2	1500lm	11W	136 lm/W	L8	4500lm	41W	109 lm/W
L3	2000lm	13W	154 lm/W	L9	5000lm	47W	106 lm/W
L4	2500lm	17W	147 lm/W	L10	6000lm	49W	122 lm/W
L5	3000lm	22W	136 lm/W	L11	7000lm	58W	121 lm/W
L6	3500lm	28W	125 lm/W				

* Delivered lumen output will vary depending on CCT, CRI, optic and reflector finish. | ** System Wattage include driver and LED Module consumption.

FEATURES

- High performance cylinder extruded from aluminum in durable powder coat finishes
- Control protocols from ELV, 0-10V, 2-Wire, DALI and DMX with options available in 0.1% and dim-to-dark

LED LIGHT ENGINE

- 82/92 CRI, 2700K, 3000K, 3500K or 4000K
- 2 Step MacAdam (2 SDCM)
- Rated life of >50,000 hours L70 based on LED testing per LM-80-08 and projected values using IESNA TM21-11

DIMMING

- Forward/Reverse Phase Dimming 5% (120V only)
- 0-10V Dimming 1%
- eldoLED 0-10V 0.1% or 1%
- Lutron® LDE1 Hi-Lume 1% EcoSystem LED driver with Soft-on, Fade-to-Black dimming technology
- DMX512 RDM 0.1%

OPTICS

- 14° Narrow Spot, 20° Spot, 30° Narrow Flood, 40° Flood, 50° Wide Flood and 60° Very Wide Flood
- Optics and filter media are field interchangeable

ELECTRICAL SYSTEM

- 120V-277V Power factor >.9, 50/60Hz
- 347V available, consult factory
- Multiple dimming drivers available
- This product complies with IEEE C62.41 for surge endurance up to 2.5KV. Additional surge protection recommended. Damage from power surge is not covered by warranty.

EMERGENCY BACKUP

Remote test switch included. External battery operates LED load of up to 7W at a minimum of 400 lumens for 90 minutes (EM7), or 20W at a minimum of 1200 lumens for 90 minutes (EM20).

REFLECTOR

Specification grade reflector with 1.5mm thickness. Reflector available in black, clear specular, haze or white. Meets RP-1 requirements with controlled light distribution at a 55° cut off.

REMOTE DRIVER ENCLOSURE

- Galvanized steel construction
- 50ft remote distance maximum

ACCESSORIES

Luminaire accepts (1) media filter and (1) hex cell louver.

MOUNTING

- Surface mount for direct installation to 3" or 4" Octagonal J-Box.
- 144" Aircraft cable is supplied with canopy assembly
- Pendant stems supplied with complete canopy assembly.
- Supplied aircraft cables and slope pendant stems are cuttable and can be modified in the field.

LISTING / WARRANTY

- ETL Listed to US and Canadian standards for damp locations
- 5-Year Intense LED Limited Warranty



Gravity™



Dimension are on Page 2

Accessories

- PFL2-111 (Linear Spread)
- PFL4-111 (Solite Soft Focus Lens)
- PFLMB-111 (Black Hex Louver)

Cylinder Part Number (Example: GC6DRREML527-NSWWC144)

Cylinder	Wattage	CCT / CRI	Optic	Cylinder Finish	Reflector Finish	Mounting
GC6DRREM	L1 ¹ (10W)	L7 (36W)	27 (2700K/82CRI)	-NS ⁴ (14° Narrow Spot)	W (White)	C144 (144" Aircraft Cable)
	L2 ¹ (12W)	L8 (43W)	279 (2700K/92 CRI)	-SP (20° Spot)	B (Black)	P12 (12" Slope Pendant)
	L3 (14W)	L9 (49W)	30 (3000K/82 CRI)	-NF (30° Narrow Flood)	C (Clear)	P24 (24" Slope Pendant)
	L4 (18W)	L10 (50W)	309 (3000K/92 CRI)	-FL (40° Flood)	B ⁹ (Black)	P36 ¹⁰ (36" Slope Pendant)
	L5 (23W)	L11 (60W)	35 (3500K/82 CRI)	-WF ⁷ (50° Wide Flood)		P48 (48" Slope Pendant)
	L6 (30W)		359 (3500K/92 CRI)	-VF ⁸ (60° Very Wide Flood)		P96 ¹¹ (96" Slope Pendant)
			40 (4000K/82 CRI)			S (Surface)
		409 (4000K/92 CRI)				

Remote Emergency Power Box (Example: REMGC6L1EM20)

Power Box	LED Light Engine	Dimming	Emergency Back Up
REMG6C	L1 ¹ (10W)	L7 (36W)	EM7 (7W Emergency Backup w/ Remote Test Switch IOTA part #ILB-CP07-A)
	L2 ¹ (12W)	L8 (43W)	
	L3 (14W)	L9 (49W)	EM20 ¹² (20W Emergency Backup w/ Remote Test Switch IOTA ILB-CP20-HE-A)
	L4 (18W)	L10 (50W)	
	L5 (23W)	L11 (60W)	
	L6 (30W)		

Notes:

- L1 & L2 only available with -D101
- eldoLED dimming available with L3-L10
- Lutron® dimming available with L3-L8
- Available in 120V only, not available with L11
- DMX512 RDM available with L4-L10
- 14° Optic (NS) available on L1-L9 only
- Does not accept filter media accessories from L3-L9
- 60° Optic (VF) available on L10-L11 only. Does not accept filter media accessories.
- Consult factory for lead times
- Special order. Note: 36" Pendant is made with (1) 12" & 24" w/ coupler
- (2) 48" Stems with coupler
- Not available in L1 & L4

GRAVITY CYLINDERS L/M-0317;26 P-1

INTENSE LIGHTING | 725 Landwehr Road, Northbrook, IL 60062 | tel 714 630-9877 | fax 847 559-5505

For Intense Lighting's limited product warranty, go to www.intenselighting.com. For a printed copy of the warranty, you may call 714 630-9877.

© 2026 Intense Lighting, LLC. All rights reserved. Note: This document is subject to change without notice.

GC6DRREM

6" Gravity LED Downlight Cylinder With Remote Driver Enclosure

JOB NAME		CATALOG NUMBER	
NOTES		TYPE	

Surface Mount

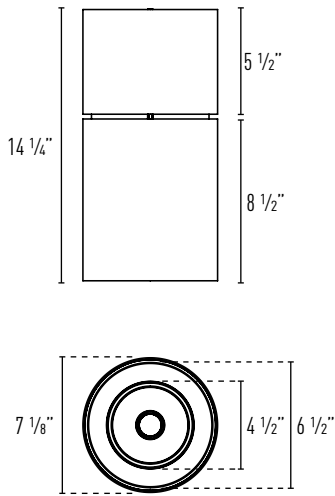

Aircraft Cable

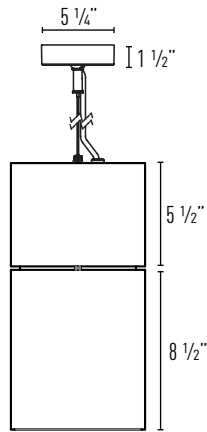

Pendant Mount

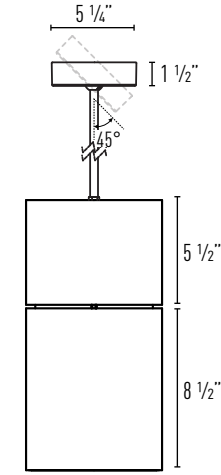

Canopy can be mounted at a maximum angle of 45°

Remote Driver Enclosure

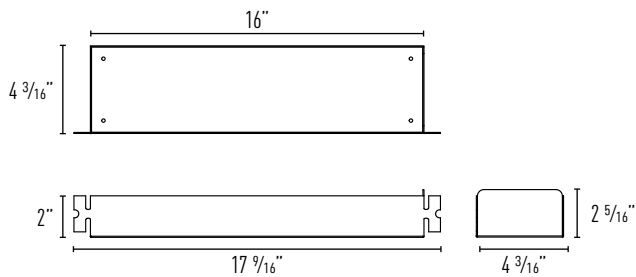

Emergency Backup

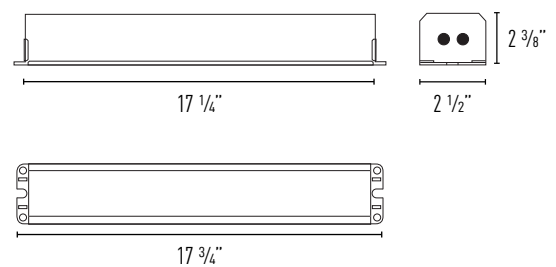

JOB NAME		CATALOG NUMBER	
NOTES		TYPE	

GC6DRL330HZ

Report #: ILL20191216-4.001 (14)
 ILL20191216-11.001 (20)
 ILL20191217-7.001 (30)
 ILL20191217-14.001 (40)
 ILL20191218-5.001 (50)

CCT MULTIPLIERS:

	82 CRI	92 CRI
2700K	(x 0.95)	(x 0.79)
3000K	(x 1.00)	(x 0.82)
3500K	(x 1.02)	(x 0.85)
4000K	(x 1.03)	(x 0.88)

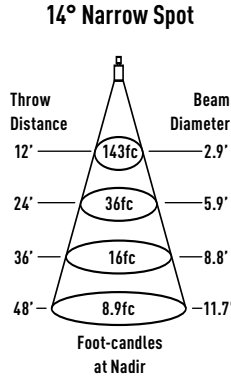

Watts: 13 LPW: 162
 Lumens: 2112 CCT: 3000K

Intensity	
Degree	CBCP
0°	20572
5°	15552
15°	1738
25°	832
35°	46
45°	35

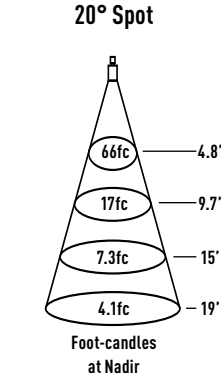

Watts: 13 LPW: 158
 Lumens: 2053 CCT: 3000K

Intensity	
Degree	CBCP
0°	9494
5°	8077
15°	2830
25°	863
35°	70
45°	47

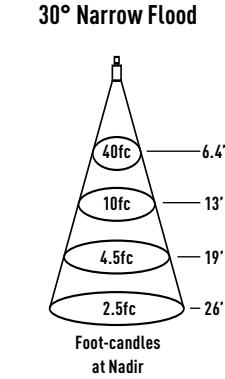

Watts: 13 LPW: 156
 Lumens: 2031 CCT: 3000K

Intensity	
Degree	CBCP
0°	5821
5°	5453
15°	2888
25°	1219
35°	99
45°	37

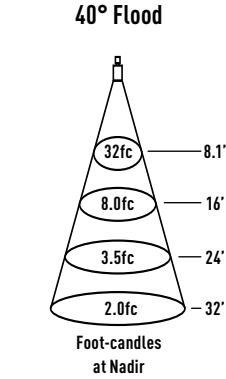

Watts: 13 LPW: 154
 Lumens: 2005 CCT: 3000K

Intensity	
Degree	CBCP
0°	4596
5°	4405
15°	2942
25°	1301
35°	107
45°	48

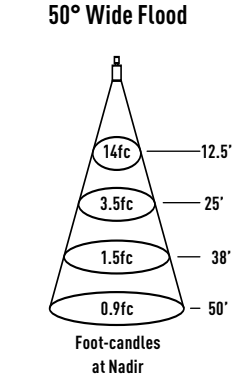

Watts: 13 LPW: 139
 Lumens: 1806 CCT: 3000K

Intensity	
Degree	CBCP
0°	2008
5°	1965
15°	1663
25°	1167
35°	565
45°	196

GC6DRL430HZ

Report #: ILL20191216-4.002 (14)
 ILL20191216-11.002 (20)
 ILL20191217-7.002 (30)
 ILL20191217-14.002 (40)
 ILL20191218-5.002 (50)

CCT MULTIPLIERS:

	82 CRI	92 CRI
2700K	(x 0.95)	(x 0.79)
3000K	(x 1.00)	(x 0.82)
3500K	(x 1.02)	(x 0.85)
4000K	(x 1.03)	(x 0.88)

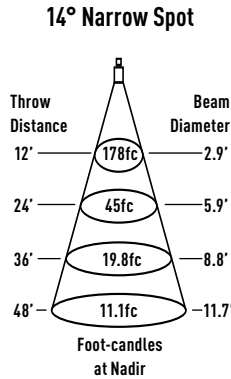

Watts: 17 LPW: 155
 Lumens: 2636 CCT: 3000K

Intensity	
Degree	CBCP
0°	25682
5°	19415
15°	2170
25°	1039
35°	57
45°	44

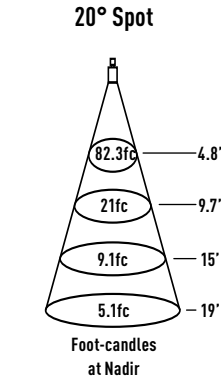

Watts: 17 LPW: 151
 Lumens: 2563 CCT: 3000K

Intensity	
Degree	CBCP
0°	11852
5°	10084
15°	3533
25°	1078
35°	87
45°	59

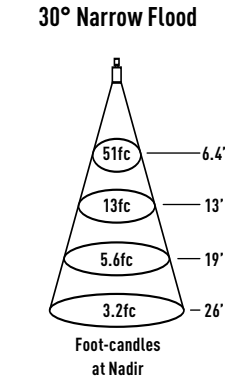

Watts: 17 LPW: 149
 Lumens: 2535 CCT: 3000K

Intensity	
Degree	CBCP
0°	7266
5°	6807
15°	3605
25°	1521
35°	123
45°	46

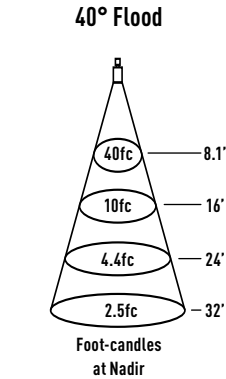

Watts: 17 LPW: 147
 Lumens: 2503 CCT: 3000K

Intensity	
Degree	CBCP
0°	5738
5°	5499
15°	3672
25°	1624
35°	134
45°	60

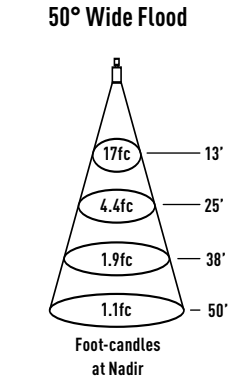

Watts: 17 LPW: 133
 Lumens: 2255 CCT: 3000K

Intensity	
Degree	CBCP
0°	2507
5°	2453
15°	2076
25°	1457
35°	706
45°	245

JOB NAME		CATALOG NUMBER	
NOTES		TYPE	

GC6DRL530HZ

Report #: ILL20191216-4.003 (14)
 ILL20191216-11.003 (20)
 ILL20191217-7.003 (30)
 ILL20191217-14.003 (40)
 ILL20191218-5.003 (50)

CCT MULTIPLIERS:

	82 CRI	92 CRI
2700K	(x 0.95)	(x 0.79)
3000K	(x 1.00)	(x 0.82)
3500K	(x 1.02)	(x 0.85)
4000K	(x 1.03)	(x 0.88)

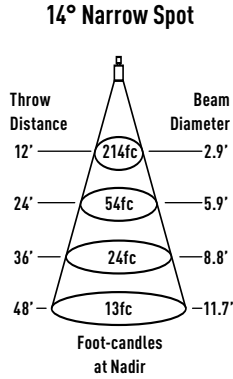

Watts: 22 LPW: 144
 Lumens: 3165 CCT: 3000K

Intensity	
Degree	CBCP
0°	30837
5°	23311
15°	2606
25°	1247
35°	69
45°	53

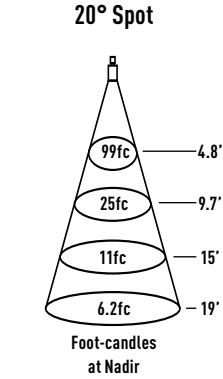

Watts: 22 LPW: 140
 Lumens: 3077 CCT: 3000K

Intensity	
Degree	CBCP
0°	14231
5°	12107
15°	4242
25°	1294
35°	104
45°	71

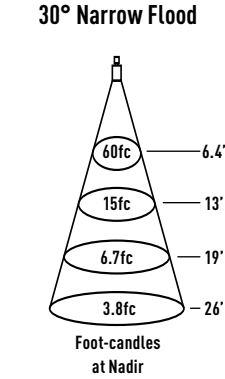

Watts: 23 LPW: 132
 Lumens: 3044 CCT: 3000K

Intensity	
Degree	CBCP
0°	8725
5°	8173
15°	4329
25°	1827
35°	148
45°	55

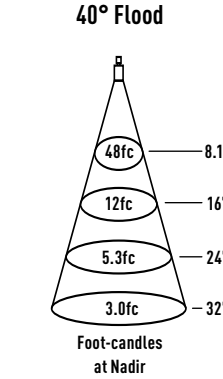

Watts: 22 LPW: 137
 Lumens: 3005 CCT: 3000K

Intensity	
Degree	CBCP
0°	6889
5°	6602
15°	4409
25°	1950
35°	160
45°	71

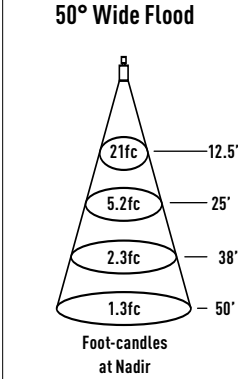

Watts: 22 LPW: 123
 Lumens: 2708 CCT: 3000K

Intensity	
Degree	CBCP
0°	3011
5°	2945
15°	2493
25°	1749
35°	848
45°	294

GC6DRL630HZ

Report #: ILL20191216-4.004 (14)
 ILL20191216-11.004 (20)
 ILL20191217-7.004 (30)
 ILL20191217-14.004 (40)
 ILL20191218-5.004 (50)

CCT MULTIPLIERS:

	82 CRI	92 CRI
2700K	(x 0.95)	(x 0.79)
3000K	(x 1.00)	(x 0.82)
3500K	(x 1.02)	(x 0.85)
4000K	(x 1.03)	(x 0.88)

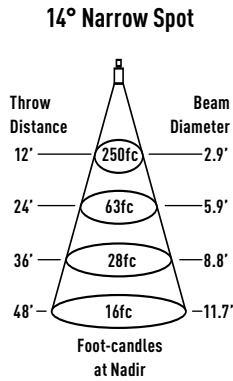

Watts: 28 LPW: 132
 Lumens: 3694 CCT: 3000K

Intensity	
Degree	CBCP
0°	35991
5°	27208
15°	3041
25°	1455
35°	81
45°	62

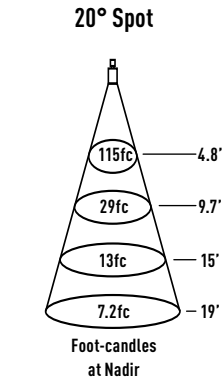

Watts: 28 LPW: 128
 Lumens: 3592 CCT: 3000K

Intensity	
Degree	CBCP
0°	16610
5°	14131
15°	4951
25°	1510
35°	122
45°	83

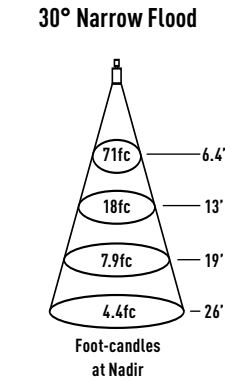

Watts: 28 LPW: 127
 Lumens: 3553 CCT: 3000K

Intensity	
Degree	CBCP
0°	10183
5°	9539
15°	5053
25°	2132
35°	173
45°	95

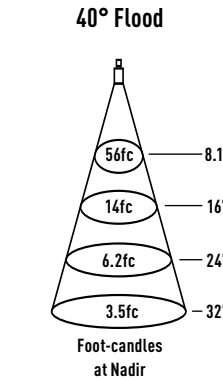

Watts: 28 LPW: 125
 Lumens: 3507 CCT: 3000K

Intensity	
Degree	CBCP
0°	8040
5°	7706
15°	5146
25°	2276
35°	187
45°	83

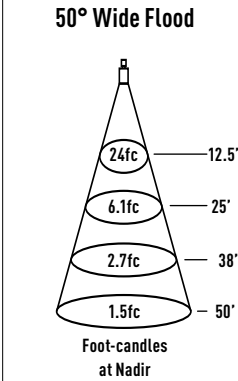

Watts: 28 LPW: 113
 Lumens: 3160 CCT: 3000K

Intensity	
Degree	CBCP
0°	3514
5°	3437
15°	2910
25°	2041
35°	989
45°	343