

GDS2DR

2" Gravity LED Shallow Lensed Downlight - Wet Location

ELECTRICAL DATA

LED Light Engine	Nominal Delivered Lumens*	System Wattage**
L1	800lm @ 3000K / 82CRI	10 Watts
L2	1100lm @ 3000K / 82CRI	15 Watts

* Delivered Lumens will vary depending on CCT, CRI, optic and reflector finish. | ** System Wattage includes driver and LED Module consumption.

FEATURES

- Field changeable 16° to 60° optics
- Integral field changeable accessory holder
- In-field adjustable collar height accommodates 1/2" to 1-1/4" ceiling thickness

LED LIGHT ENGINE

- 10W & 15W
- 16° to 60° Optics: 2 SDCM, 82/92CRI in 2700K, 3000K, 3500K & 4000K
- Rated life of >50,000 hours L70 based on LED testing per LM-80-08 and projected values using IESNA TM21-11

OPTICS

- Field changeable 16° Spot, 24° Narrow Flood, 36° Flood, 48° Wide Flood and 60° Very Wide Flood
- Accepts (2) field changeable filter media

ELECTRICAL SYSTEM

- 120V/277V input; Power factor >.9, 50/60Hz
- This product complies with IEEE C62.41 for surge endurance up to 2.5KV. Additional surge protection recommended. Damage from power surge is not covered by warranty.

HOUSING

- Heavy duty black powder coated 18 gauge steel frame
- Accommodates 1/2" to 1-1/4" Ceilings
- Integral driver compartment with below ceiling access

EMERGENCY BACKUP

- Remote test switch included. External Battery operates LED load @ 725 nominal delivered Lumens. Servicing requires above ceiling access.

INSTALLATION

- Non-IC rated housings must be kept at a minimum of 3" away from insulation
- Adjustable (10-3/4" to 25") joist/grid ceiling bar hangers included (Hanger bars does not allow for height adjustments)

REFLECTOR

- Specification grade 1.0mm spun aluminum reflector with architectural, discrete polished self flange
- Deep cone option for maximum visual comfort
- Reflector available in black, white or haze finishes (Consult factory for other finishes)

DIMMING

- Phase dimming, Forward 1% & Reversed 5% (120V only)
- 0-10V 1% Dimming 1%
- EldoLED SOLOdrive 0-10V 0.1%
- EldoLED ECOdrive 0-10V 1%
- Lutron® LDE1 Hi-Lume 1% EcoSystem LED driver with Soft-on, Fade-to-Black dimming technology

REMOTE BOX

- Remote box included when required by specification (eldoLED or Lutron dimming option).
- Above ceiling access required for servicing
- Galvanized steel construction with separate line voltage and low voltage wiring compartments
- 50ft remote distance maximum

LISTING / WARRANTY

- 5-Year Intense LED Limited Warranty
- ETL Listed to US and Canadian standards for wet locations (IC / AIC Only) ETL listed for direct contact w/insulation
- (AIC Only) Air-Tight Certified ASTM E283.
- (AIC Only) Can be used to comply with Title 24, Part 6, JA8 high efficacy LED light source requirements



JOB NAME	CATALOG NUMBER
NOTES	TYPE

Trimmed Reflectors

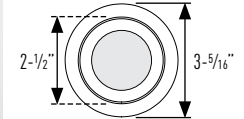
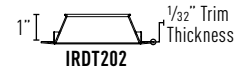

Ceiling Cutout: 2-7/8"

Trimless Reflectors

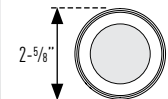
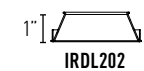

Ceiling Cutout: 2-7/8"

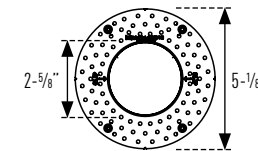

Trimless Mud Flanged:
Perforated collar for seamless and trimless mounting. Must be ordered separately and can only be used in conjunction with trimless trims.

Available Trim Finishes



Housing Part Number: (Example: GDS2ARNCL1279DIMUNVSP)

Housing	Installation Type	Wattage	CCT / CRI	Dimming	Voltage	Optic	Options
GDS2DR	NIC (New Cons IC-Rated)	L1 (10W)	27 (2700K / 82CRI)	DIM ¹ (Phase Dimming)	UNV (Universal, 120V/277V)	SP (16° SP)	EM7 ² (7W Emergency Backup IOTA part #ILB-CP07-A)
		L2 (15W)	279 (2700K / 92CRI)				
	NAIC (New Cons Air-Tight IC)	30 (3000K / 82CRI)	30 (3000K / 82CRI)	ED10V1 ² (eldoLED 0-10V 1%)			
		309 (3000K / 92CRI)	309 (3000K / 92CRI)	ED10V01 ² (eldoLED 0-10V 0.1%)			
		35 (3500K / 82CRI)	35 (3500K / 82CRI)	LUT ^{2,3} (Lutron® LDE1 EcoSystem 1%)			
		359 (3500K / 92CRI)	359 (3500K / 92CRI)				
		40 (4000K / 82CRI)	40 (4000K / 82CRI)				
		409 (4000K / 92CRI)	409 (4000K / 92CRI)				

Reflector Part Number: (Example: IRDT202W-SF)

Reflector	Reflector Finish	Trim	Lens
IRDT202 (1" Regress Trim)	W (White)	-SF (Self Flanged)	-SL (Solite)
IRDL202 ⁴ (1" Regress Trimless)	B ⁵ (Black)	blank ⁴ (Trimless)	
	HZ (Haze)		

Optional Accessory

GD2R-MR⁴ Round Trimless Mud Ring

Filter Media

PFL2-45 Hex Lower
PFL4-45 Soft Focus Film
PFL-LS-45 Linear Spread

Notes:

- Available in 120V only
- Remote driver box required for eldoLED, Lutron and EM backup
- Not available with L3
- Trimless options are for use with mud ring accessory only
- Consult factory for lead times

Intense Lighting

GDS2DR

2" Gravity LED Shallow Lensed Downlight - Wet Location

JOB NAME		CATALOG NUMBER	
NOTES		TYPE	

Shallow New Construction IC & AIC Rated Dimension:

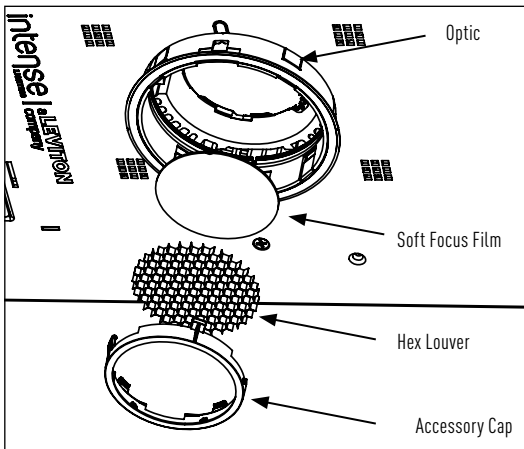
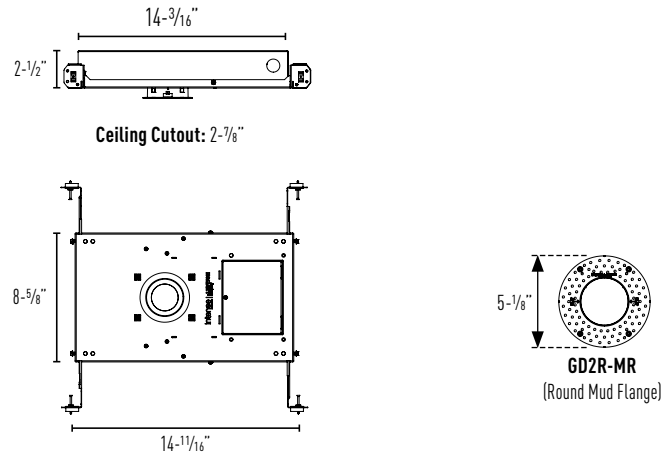

Optics

Field changeable 16° to 60° Optics

- IP-OP45SP** (16° Spot)
- IP-OP45NF** (24° Narrow Flood)
- IP-OP45FL** (36° Flood)
- IP-OP45WF** (48° Wide Flood)
- IP-OP45VF** (60° Very Wide Flood)

Accessories

- PFL2-45** Hex Louver
- PFL4-45** Soft Focus Film

Remote Mounted Driver

(For use with IC/AIC housings with eldoLED or Lutron dimming option)

- Remote box included when required by specification (eldoLED or Lutron dimming option).
- Above ceiling access required for servicing
- Galvanized steel construction with separate line voltage and low voltage wiring compartments
- 50ft remote distance maximum

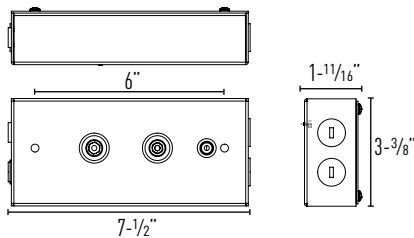

Remote Driver Box For Dimming Options

- eldoLED 0-10V 1%
- eldoLED 0-10V 0.1%
- Lutron® LDE1 EcoSystem 1%
- Lutron® LTEA2W 2-Wire 1%

Note: Wires for class 2 LED driver require a minimum of 18 awg wire at a maximum of 50 feet length per local and national electrical regulations.

GDS2DR

2" Gravity LED Shallow Lensed Downlight - Wet Location

JOB NAME		CATALOG NUMBER	
NOTES		TYPE	

IRDT202WL2

Report #: ILL-20190114-1 (16)
 ILL-20190114-1 (24)
 ILL-20190114-1 (36)
 ILL-20190114-1 (48)
 ILL-20190114-1 (60)

IRRT202 (% REGRESS)
 Trim Multiplier (x 0.99)

CCT MULTIPLIERS:

	82CRI	92CRI
2700K	(x 0.93)	(x 0.76)
3000K	(x 1.00)	(x 0.87)
3500K	(x 1.00)	(x 0.87)
4000K	(x 1.00)	(x 0.87)

16° Spot

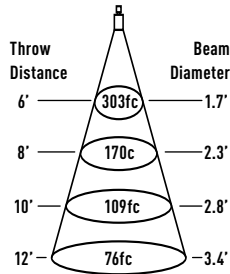

Foot-candles at Nadir
 Watts: 15 LPW: 73
 Lumens: 1100 CCT: 3000K

Intensity	
Degree	CBCP
0°	10899
5°	8329
15°	1348
25°	246
35°	37
45°	11

24° Narrow Flood

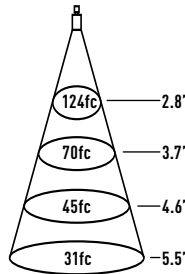

Foot-candles at Nadir
 Watts: 15 LPW: 73
 Lumens: 1100 CCT: 3000K

Intensity	
Degree	CBCP
0°	4451
5°	3952
15°	1797
25°	500
35°	98
45°	20

36° Flood

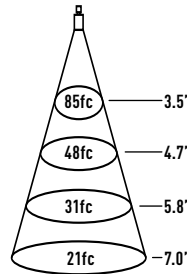

Foot-candles at Nadir
 Watts: 15 LPW: 73
 Lumens: 1100 CCT: 3000K

Intensity	
Degree	CBCP
0°	3048
5°	2849
15°	1694
25°	627
35°	157
45°	31

48° Wide Flood

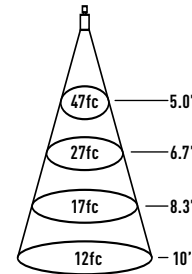

Foot-candles at Nadir
 Watts: 15 LPW: 73
 Lumens: 1100 CCT: 3000K

Intensity	
Degree	CBCP
0°	1696
5°	1636
15°	1269
25°	718
35°	277
45°	72

60° Very Wide Flood

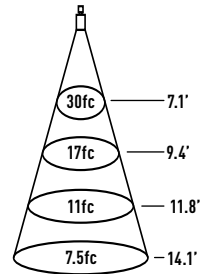

Foot-candles at Nadir
 Watts: 15 LPW: 63
 Lumens: 1100 CCT: 3000K

Intensity	
Degree	CBCP
0°	1074
5°	1049
15°	939
25°	705
35°	377
45°	114