

GDS2DS

2" Gravity LED Square Shallow Lensed Downlight - Wet Location

| | | | |
|-----------------|--|-----------------------|--|
| JOB NAME | | CATALOG NUMBER | |
| NOTES | | TYPE | |

ELECTRICAL DATA

| LED Light Engine | Nominal Delivered Lumens* | System Wattage** |
|------------------|---------------------------|------------------|
| L1 | 650lm @ 3000K / 82CRI | 10 Watts |
| L2 | 900lm @ 3000K / 82CRI | 15 Watts |

* Delivered Lumens will vary depending on CCT, CRI, optic and reflector finish. | ** System Wattage includes driver and LED Module consumption.

FEATURES

- Field changeable 16° to 60° optics
- Integral field changeable accessory holder
- In-field adjustable collar height accommodates 1/2" to 1-1/4" ceiling thickness

LED LIGHT ENGINE

- 10W & 15W
- 16° to 60° Optics: 2 SDCM, 82/92CRI in 2700K, 3000K, 3500K & 4000K
- Rated life of >50,000 hours L70 based on LED testing per LM-80-08 and projected values using IESNA TM21-11

OPTICS

- Field changeable 16° Spot, 24° Narrow Flood, 36° Flood, 48° Wide Flood and 60° Very Wide Flood
- Accepts (2) field changeable filter media

ELECTRICAL SYSTEM

- 120V/277V input; Power factor >.9, 50/60Hz
- This product complies with IEEE C62.41 for surge endurance up to 2.5KV. Additional surge protection recommended. Damage from power surge is not covered by warranty.

HOUSING

- Heavy duty black powder coated 18 gauge steel frame
- Accommodates 1/2" to 1-1/4" Ceilings
- Integral driver compartment with below ceiling access

EMERGENCY BACKUP

- Remote test switch included. External Battery operates LED load @ 725 nominal delivered Lumens. Servicing requires above ceiling access.

INSTALLATION

- Non-IC rated housings must be kept at a minimum of 3" away from insulation
- Adjustable (10-3/4" to 25") joist/grid ceiling bar hangers included (Hanger bars does not allow for height adjustments)

REFLECTOR

- Specification grade 1.0mm spun aluminum reflector with architectural, discrete polished self flange
- Reflector available in black, white or haze finishes (Consult factory for other finishes)

DIMMING

- Phase dimming, Forward 1% & Reversed 5% (120V only)
- 0-10V 1% Dimming 1%
- EldoLED SOLOdrive 0-10V 0.1%
- EldoLED ECOdrive 0-10V 1%
- Lutron® LDE1 Hi-Lume 1% EcoSystem LED driver with Soft-on, Fade-to-Black dimming technology

REMOTE BOX

- Remote box included when required by specification (eldoLED or Lutron dimming option).
- Above ceiling access required for servicing
- Galvanized steel construction with separate line voltage and low voltage wiring compartments
- 50ft remote distance maximum

LISTING / WARRANTY

- 5-Year Intense LED Limited Warranty
- ETL Listed to US and Canadian standards for wet locations
- (IC / AIC Only) ETL listed for direct contact w/insulation
- (AIC Only) Air-Tight Certified ASTM E283.
- (AIC Only) Can be used to comply with Title 24, Part 6, JA8 high efficacy LED light source requirements



Trimmed Reflectors

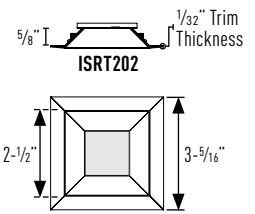
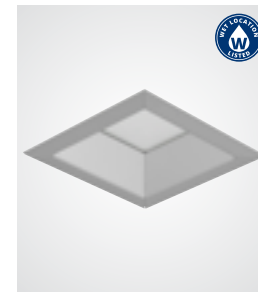

Ceiling Cutout: 2-7/8"

Trimless Reflectors

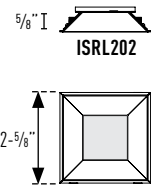
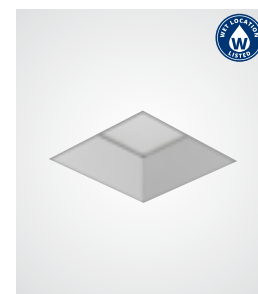

Ceiling Cutout: 2-7/8"

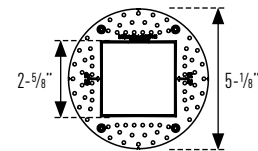

Trimless Mud Flanged:
Perforated collar for seamless and trimless mounting. Must be ordered separately and can only be used in conjunction with trimless trims.

Available Trim Finishes

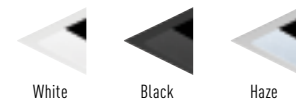

Housing Part Number: (Example: GDS2DSNCL1279DIMUNVSP)

| Housing | Installation Type | Wattage | CCT / CRI | Dimming | Voltage | Optic | Options |
|---------|------------------------------|---------------------|---|----------------------------------|----------------------------|--|--|
| GDS2DS | NIC (New Cons IC-Rated) | L1 (10W) | 27 (2700K / 82CRI) | DIM ¹ (Phase Dimming) | UNV (Universal, 120V/277V) | SP (16° SP) NF (24° NFL) FL (36° FL) WF (48° WFL) VF (60° VFL) | EM7 ² (7W Emergency Backup IOTA part #ILB-CP07-A) |
| | | L2 (15W) | 279 (2700K / 92CRI) | | | | |
| | NAIC (New Cons Air-Tight IC) | 30 (3000K / 82CRI) | ED10V1 ² (eldoLED 0-10V 1%) ED10V01 ² (eldoLED 0-10V 0.1%) LUT ^{2,3} (Lutron® LDE1 EcoSystem 1%) | | | | |
| | | 309 (3000K / 92CRI) | | | | | |
| | | 35 (3500K / 82CRI) | | | | | |
| | | 359 (3500K / 92CRI) | | | | | |
| | | 40 (4000K / 82CRI) | | | | | |
| | | 409 (4000K / 92CRI) | | | | | |

Reflector Part Number: (Example: ISRT202W-SF)

| Reflector | Reflector Finish | Trim | Lens |
|--|-------------------------------------|-------------------------------|--------------|
| ISRT202 (5% Regress Trim) | W (White) | -SF (Self Flanged) | -SL (Solite) |
| ISRL202 ⁴ (5% Regress Trimless) | B ⁵ (Black) HZ (Haze) | blank ⁴ (Trimless) | |

Optional Accessory

GD2S-MR⁴ Square Trimless Mud Ring

Filter Media

PFL2-45 Hex Louver
PFL4-45 Soft Focus Film
PFL-LS-45 Linear Spread

Notes:

- Available in 120V only
- Remote driver box required for eldoLED, Lutron and EM backup
- Not available with L3
- Trimless options are for use with mud ring accessory only
- Consult factory for lead times

GRAVITY LJM-0430-25 P-10

Intense Lighting

3340 E La Palma Ave, Anaheim, CA 92806 | tel 714 630-9877 | fax 714 630-9883

©2025 Intense Lighting, LLC. All rights reserved. Subject to change without notice.

GDS2DS

2" Gravity LED Square Shallow Lensed Downlight - Wet Location

| | | | |
|-----------------|--|-----------------------|--|
| JOB NAME | | CATALOG NUMBER | |
| NOTES | | TYPE | |

Shallow New Construction IC & AIC Rated Dimension:

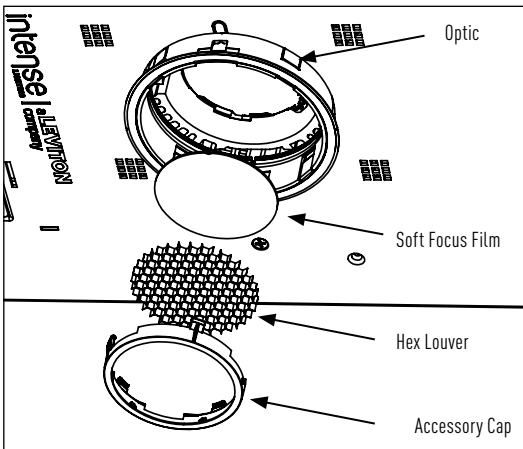
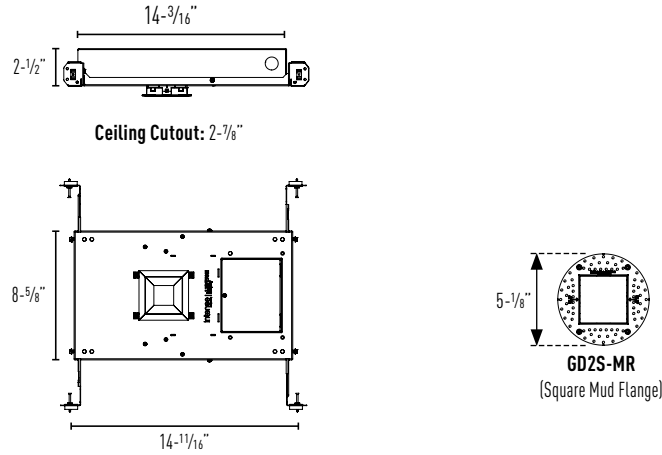

Optics

Field changeable 16° to 60° Optics

- IP-OP45SP** (16° Spot)
- IP-OP45NF** (24° Narrow Flood)
- IP-OP45FL** (36° Flood)
- IP-OP45WF** (48° Wide Flood)
- IP-OP45VF** (60° Very Wide Flood)

Accessories

- PFL2-45** Hex Louver
- PFL4-45** Soft Focus Film
- PFL-LS-45** Linear Spread

Remote Mounted Driver

(For use with IC/AIC housings with eldoLED or Lutron dimming option)

- Remote box included when required by specification (eldoLED or Lutron dimming option).
- Above ceiling access required for servicing
- Galvanized steel construction with separate line voltage and low voltage wiring compartments
- 50ft remote distance maximum

Remote Driver Box For Dimming Options

- eldoLED 0-10V 1%
- eldoLED 0-10V 0.1%
- Lutron® LDE1 EcoSystem 1%
- Lutron® LTEA2W 2-Wire 1%

Note: Wires for class 2 LED driver require a minimum of 18 awg wire at a maximum of 50 feet length per local and national electrical regulations.

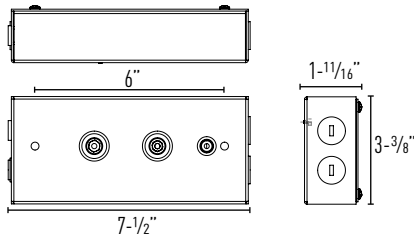

GDS2DS

2" Gravity LED Square Shallow Lensed Downlight - Wet Location

| | | | |
|----------|--|----------------|--|
| JOB NAME | | CATALOG NUMBER | |
| NOTES | | TYPE | |

ISRT202WL2

Report #: ILL-20190114-1 (16)
 ILL-20190114-1 (24)
 ILL-20190114-1 (36)
 ILL-20190114-1 (48)
 ILL-20190114-1 (60)

ISRT200 (% REGRESS)
 Trim Multiplier (x 0.99)

CCT MULTIPLIERS:

| | | |
|-------|----------|----------|
| | 82CRI | 92CRI |
| 2700K | (x 0.93) | (x 0.76) |
| 3000K | (x 1.00) | (x 0.87) |
| 3500K | (x 1.00) | (x 0.87) |
| 4000K | (x 1.00) | (x 0.87) |

16° Spot

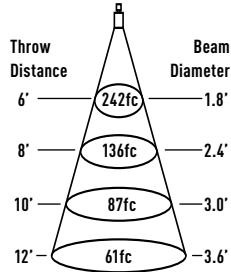

Foot-candles at Nadir

Watts: 15 LPW: 60
 Lumens: 900 CCT: 3000K

| Intensity | |
|-----------|------|
| Degree | CBCP |
| 0° | 8723 |
| 5° | 6822 |
| 15° | 1128 |
| 25° | 145 |
| 35° | 30 |
| 45° | 12 |

24° Narrow Flood

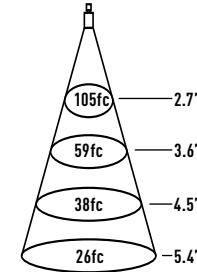

Foot-candles at Nadir

Watts: 15 LPW: 60
 Lumens: 900 CCT: 3000K

| Intensity | |
|-----------|------|
| Degree | CBCP |
| 0° | 3793 |
| 5° | 3367 |
| 15° | 1453 |
| 25° | 356 |
| 35° | 77 |
| 45° | 20 |

36° Flood

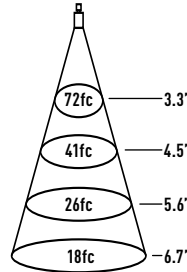

Foot-candles at Nadir

Watts: 15 LPW: 60
 Lumens: 900 CCT: 3000K

| Intensity | |
|-----------|------|
| Degree | CBCP |
| 0° | 2593 |
| 5° | 2407 |
| 15° | 1340 |
| 25° | 448 |
| 35° | 126 |
| 45° | 32 |

48° Wide Flood

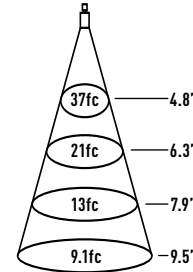

Foot-candles at Nadir

Watts: 15 LPW: 60
 Lumens: 900 CCT: 3000K

| Intensity | |
|-----------|------|
| Degree | CBCP |
| 0° | 1317 |
| 5° | 1267 |
| 15° | 941 |
| 25° | 502 |
| 35° | 218 |
| 45° | 73 |

60° Very Wide Flood

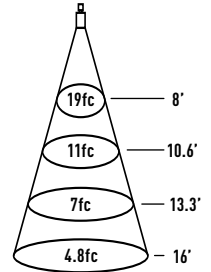

Foot-candles at Nadir

Watts: 15 LPW: 60
 Lumens: 900 CCT: 3000K

| Intensity | |
|-----------|------|
| Degree | CBCP |
| 0° | 693 |
| 5° | 686 |
| 15° | 630 |
| 25° | 493 |
| 35° | 322 |
| 45° | 134 |