

# GD4AS / ISA400

## 4" Gravity LED Square Adjustable

<b>JOB NAME</b>		<b>CATALOG NUMBER</b>	
<b>NOTES</b>		<b>TYPE</b>	

### ELECTRICAL DATA: (Data Based On 3000K/82CRI Configuration)

LED Light Engine	Nominal Delivered Lumen*	System Wattage**	Efficacy	LED Light Engine	Nominal Delivered Lumen*	System Wattage**	Efficacy
L1	1000lm	12W	83 lm/W	L6	3500lm	37W	95 lm/W
L2	1500lm	15W	100 lm/W	L7	4000lm	44W	91 lm/W
L3	2000lm	20W	100 lm/W	L8	4500lm	48W	94 lm/W
L4	2500lm	25W	100 lm/W	L9	5000lm	55W	91 lm/W
L5	3000lm	31W	97 lm/W				

\*System Wattage include driver and LED Module consumption. / \*\* Delivered lumens will vary depending on CCT, CRI and optic selection

### FEATURES

- Zero cut off up to 40° vertical adjustment ensures high delivered lumens through precise center beam optics
- Fixed collar accepts up to 1 1/4" ceiling via hanger bar notches

### LED LIGHT ENGINE

- 82/92 CRI at 2700K, 3000K, 3500K & 4000K with 2 Step MacAdam (2 SDCM)
- Rated life of >50,000 hours L70 based on LED testing per LM-80-08 and projected values using IESNA TM21-11

### DIMMING

- Phase Dimming 120V only, Forward 1% / Reverse 5%
- 0-10V Dimming 1%
- EldoLED 0-10V 0.1% or 1%
- Lutron® LDE1 Hi-Lume 1% EcoSystem LED driver with Soft-on, Fade-to-Black dimming technology
- DMX512 RDM 0.1%

### OPTICS

- 14° Narrow Spot, 20° Spot, 30° Narrow Flood, 40° Flood and 50° Wide Flood
- Optics and filter media are field customizable

### ELECTRICAL SYSTEM

- Dedicated voltage options of 120V, 277V or 347V. Must be specified in catalog code. Consult factory for 347V
- This product complies with IEEE C62.41 for surge endurance up to 2.5KV. Additional surge protection recommended. Damage from power surge is not covered by warranty.

### FRAME CONSTRUCTION

Constructed from 16 and 18 gauge heavy duty powder coated cold rolled steel frame with a large access junction box. ETL listed for through wiring. LED light engine and driver are accessible from above or below ceiling. Horizontal rotation on 90° turns and accommodates ±15° horizontal aiming adjustment off center.

### REFLECTOR

Specification grade reflector with 1.5mm thickness. Reflector available in haze, white, clear or black finish. Consult factory for other colors. Architectural, discrete polished self flange standard. Optional painted white flange is available.

### INSTALLATION

The luminaire is type Non-IC. Insulation must be kept at a minimum of 3" away from fixture. Accommodates ceiling thickness from 1/2" to 1 1/4". Universal mounting brackets included. Compatible with C-channel, flat bar, wood joist bar hanger and EMT. Bar hangers must be ordered separately. C-channel is recommended for T-bar ceilings. Max. ambient temperature: 95°F (35°C).

### EMERGENCY BACKUP

Remote test switch included. External battery operates LED load of up to 7W at a minimum of 500 lumens for 90 minutes (EM7), or 20W at a minimum of 1500 lumens for 90 minutes (EM20).

### ACCESSORIES

Luminaire will accommodate (2) accessories, accessory holder required.

### LISTING / WARRANTY

- ETL Listed to US and Canadian standards for damp locations
- 5-Year Intense LED Limited Warranty

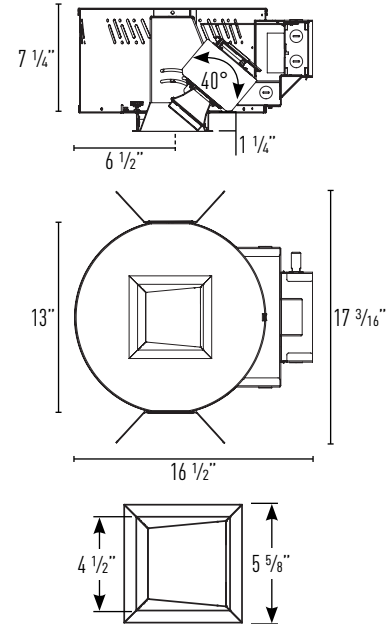

Ceiling Cut Out: 5 1/4" x 5 1/4"  
Maximum Ceiling Thickness: 1 1/4"  
Minimum Ceiling Thickness: 1/2"

### Housing Part Number: (Example: GD4ASL230-D101-NSEM7)

Housing	Wattage	CCT / CRI	Dimming	Voltage	Optic	Options
GD4AS	L1 (12W)	27 (2700K / 82 CRI)	-DIM <sup>1</sup> (Phase Dimming)	blank (120V)	-NS <sup>4</sup> (14° Narrow Spot)	EM7 (7W Emergency Backup)
	L2 (15W)	279 (2700K / 92 CRI)	-D101 (0-10V Dimming 1%)	27 (277V)	-SP (20° Spot)	IOTA part #ILB-CP07-A
	L3 (20W)	30 (3000K / 82 CRI)	-ED10V1 (eldoLED 0-10V 1%)	34 <sup>6</sup> (347V)	-NF (30° Narrow Flood)	EM20 <sup>5</sup> (20W Emergency Backup)
	L4 (25W)	309 (3000K / 92 CRI)	-ED10V01 (eldoLED 0-10V 0.1%)		-FL (40° Flood)	Bodine part #BSL20LV
	L5 (31W)	35 (3500K / 82 CRI)	-LUT <sup>2</sup> (Lutron® LDE1 EcoSystem 1%)		-WF (50° Wide Flood)	
	L6 (37W)	359 (3500K / 92 CRI)	-DMXR <sup>3</sup> (DMX512 RDM 0.1%)			
	L7 (44W)	40 (4000K / 82 CRI)				
	L8 (48W)	409 (4000K / 92 CRI)				
	L9 (55W)					

### Reflector Part Number: (Example: ISA400HZ-SF)

Reflector	Reflector Finish	Trim
ISA400	HZ (Haze)	-SF (Self Flanged)
	W (White)	-SFW <sup>7</sup> (Self Flanged White)
	C (Clear)	
	B <sup>6,7</sup> (Black)	

### Accessories (Order Separately)

LH63	(Black Accessory Holder)
LH63W	(White Accessory Holder)
PFL2-63	(Linear Spread Lens)
PFL4-63	(Solite Soft Focus Lens)
PFLMB-63	(Black Hex Louver)
I100	(C-Channel Bar Hangers)
I200	(Flat Bar Hangers)
I400	(Wood Joist Bar Hangers)

### Notes:

- Available in 120V only; not available with L9
- Lutron® dimming not available in L9
- DMX512 RDM not available with L1 & L2
- 14° Optic not available in L8 & L9
- EM20 only available for L4 to L9
- Consult factory for lead times
- Self Flanged White (-SFW) not available with White or Black Reflector Finish

GRAVITY LHM-0317.26 P-4

INTENSE LIGHTING | 725 Landwehr Road, Northbrook, IL 60062 | tel 714 630-9877

For Intense Lighting's limited product warranty, go to [www.intenselighting.com](http://www.intenselighting.com). For a printed copy of the warranty, you may call 847 559-5500.

© 2026 Intense Lighting, LLC. All rights reserved. Note: This document is subject to change without notice.

JOB NAME		CATALOG NUMBER	
NOTES		TYPE	

## G4ASL1 ISA400

Report #: ILL20190102-1.001  
ILL20181218-2.001  
ILL20181218-5.001  
ILL20181218-8.001  
ILL20181218-11.001

### CCT MULTIPLIERS:

	82 CRI	92 CRI
2700K	(x 0.95)	(x 0.79)
3000K	(x 1.00)	(x 0.82)
3500K	(x 1.02)	(x 0.85)
4000K	(x 1.03)	(x 0.88)

### -NS (14° Narrow Spot)

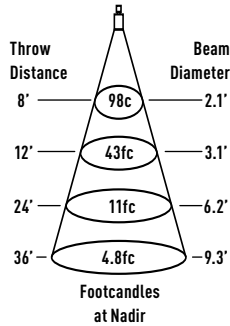

Watts: 10      LPW: 87.1  
Lumens: 871      CCT: 3000K

#### Luminance

Degree	CBCP
0°	6243
5°	4540
15°	690
25°	411
35°	46
45°	27

### -SP (20° Spot)

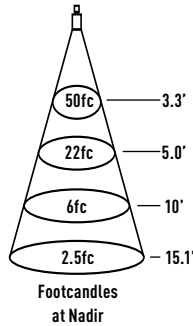

Watts: 10      LPW: 89.4  
Lumens: 894      CCT: 3000K

#### Luminance

Degree	CBCP
0°	3203
5°	2874
15°	1112
25°	430
35°	64
45°	33

### -NF (30° Narrow Flood)

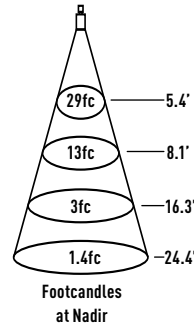

Watts: 10      LPW: 91.6  
Lumens: 916      CCT: 3000K

#### Luminance

Degree	CBCP
0°	1856
5°	1767
15°	1179
25°	560
35°	107
45°	39

### -FL (40° Flood)

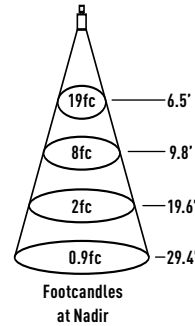

Watts: 10      LPW: 80.8  
Lumens: 808      CCT: 3000K

#### Luminance

Degree	CBCP
0°	1196
5°	1148
15°	860
25°	483
35°	176
45°	70

### -WF (50° Wide Flood)

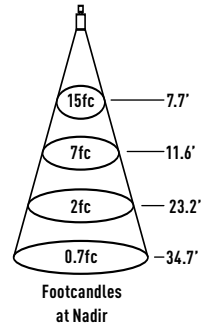

Watts: 10      LPW: 80.8  
Lumens: 808      CCT: 3000K

#### Luminance

Degree	CBCP
0°	957
5°	940
15°	799
25°	507
35°	203
45°	78

## G4ASL2 ISA400

Report #: ILL20190102-1.002  
ILL20181218-2.002  
ILL20181218-5.002  
ILL20181218-8.002  
ILL20181218-11.002

### CCT MULTIPLIERS:

	82 CRI	92 CRI
2700K	(x 0.95)	(x 0.79)
3000K	(x 1.00)	(x 0.82)
3500K	(x 1.02)	(x 0.85)
4000K	(x 1.03)	(x 0.88)

### -NS (14° Narrow Spot)

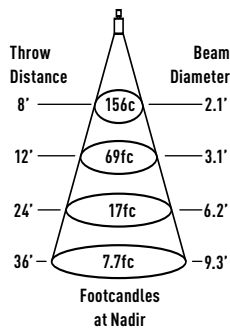

Watts: 14      LPW: 99.2  
Lumens: 1389      CCT: 3000K

#### Luminance

Degree	CBCP
0°	9955
5°	7240
15°	1101
25°	655
35°	74
45°	44

### -SP (20° Spot)

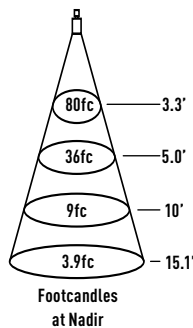

Watts: 14      LPW: 101.8  
Lumens: 1425      CCT: 3000K

#### Luminance

Degree	CBCP
0°	5107
5°	4583
15°	1774
25°	686
35°	103
45°	53

### -NF (30° Narrow Flood)

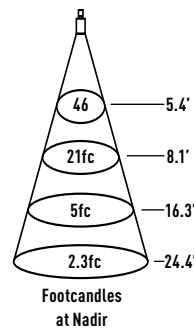

Watts: 14      LPW: 104.3  
Lumens: 1460      CCT: 3000K

#### Luminance

Degree	CBCP
0°	2960
5°	2817
15°	1879
25°	893
35°	170
45°	62

### -FL (40° Flood)

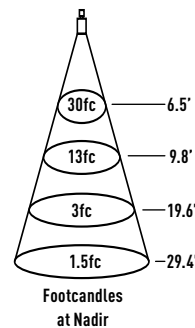

Watts: 14      LPW: 92.1  
Lumens: 1289      CCT: 3000K

#### Luminance

Degree	CBCP
0°	1907
5°	1831
15°	1372
25°	771
35°	280
45°	111

### -WF (50° Wide Flood)

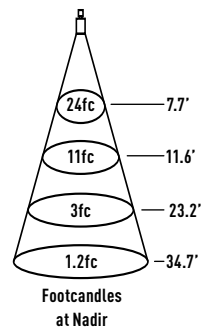

Watts: 14      LPW: 92  
Lumens: 1288      CCT: 3000K

#### Luminance

Degree	CBCP
0°	1526
5°	1498
15°	1275
25°	808
35°	324
45°	124

JOB NAME		CATALOG NUMBER	
NOTES		TYPE	

## G4ASL3 ISA400

Report #: ILL20190102-1.003  
ILL20181218-2.003  
ILL20181218-5.003  
ILL20181218-8.003  
ILL20181218-11.003

### CCT MULTIPLIERS:

	82 CRI	92 CRI
2700K	(x 0.95)	(x 0.79)
3000K	(x 1.00)	(x 0.82)
3500K	(x 1.02)	(x 0.85)
4000K	(x 1.03)	(x 0.88)

### -NS (14° Narrow Spot)

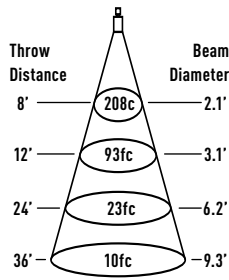

Footcandles at Nadir  
Watts: 19      LPW: 97.9  
Lumens: 1859      CCT: 3000K

Luminance	
Degree	CBCP
0°	13330
5°	9694
15°	1474
25°	877
35°	99
45°	59

### -SP (20° Spot)

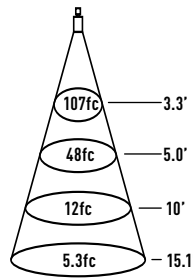

Footcandles at Nadir  
Watts: 19      LPW: 100.4  
Lumens: 1908      CCT: 3000K

Luminance	
Degree	CBCP
0°	6839
5°	6137
15°	2375
25°	918
35°	137
45°	71

### -NF (30° Narrow Flood)

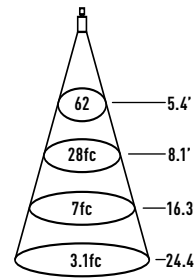

Footcandles at Nadir  
Watts: 19      LPW: 102.9  
Lumens: 1955      CCT: 3000K

Luminance	
Degree	CBCP
0°	3963
5°	3772
15°	2516
25°	1195
35°	228
45°	83

### -FL (40° Flood)

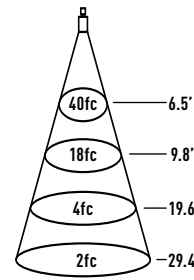

Footcandles at Nadir  
Watts: 19      LPW: 90.8  
Lumens: 1726      CCT: 3000K

Luminance	
Degree	CBCP
0°	2553
5°	2452
15°	1837
25°	1032
35°	375
45°	148

### -WF (50° Wide Flood)

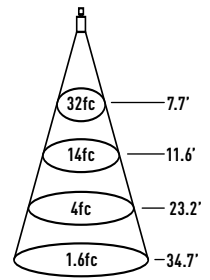

Footcandles at Nadir  
Watts: 19      LPW: 90.8  
Lumens: 1725      CCT: 3000K

Luminance	
Degree	CBCP
0°	2043
5°	2006
15°	1707
25°	1082
35°	434
45°	166

## G4ASL4 ISA400

Report #: ILL20190102-1.004  
ILL20181218-2.004  
ILL20181218-5.004  
ILL20181218-8.004  
ILL20181218-11.004

### CCT MULTIPLIERS:

	82 CRI	92 CRI
2700K	(x 0.95)	(x 0.79)
3000K	(x 1.00)	(x 0.82)
3500K	(x 1.02)	(x 0.85)
4000K	(x 1.03)	(x 0.88)

### -NS (14° Narrow Spot)

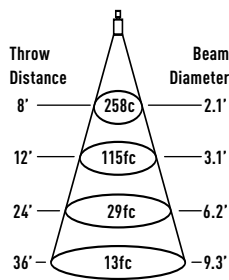

Footcandles at Nadir  
Watts: 24      LPW: 96.1  
Lumens: 2307      CCT: 3000K

Luminance	
Degree	CBCP
0°	16536
5°	12025
15°	1829
25°	1088
35°	12
45°	73

### -SP (20° Spot)

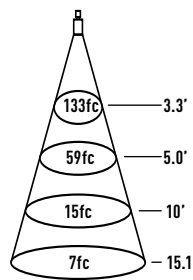

Footcandles at Nadir  
Watts: 24      LPW: 98.6  
Lumens: 2367      CCT: 3000K

Luminance	
Degree	CBCP
0°	8484
5°	7613
15°	2946
25°	1139
35°	170
45°	88

### -NF (30° Narrow Flood)

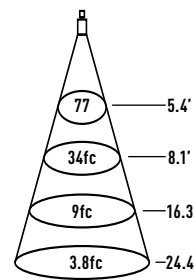

Footcandles at Nadir  
Watts: 24      LPW: 101  
Lumens: 2425      CCT: 3000K

Luminance	
Degree	CBCP
0°	4917
5°	4680
15°	3122
25°	1483
35°	283
45°	103

### -FL (40° Flood)

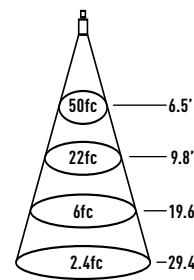

Footcandles at Nadir  
Watts: 24      LPW: 89.2  
Lumens: 2141      CCT: 3000K

Luminance	
Degree	CBCP
0°	3167
5°	3041
15°	2279
25°	1280
35°	466
45°	184

### -WF (50° Wide Flood)

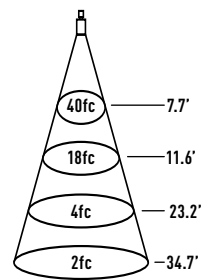

Footcandles at Nadir  
Watts: 24      LPW: 89.2  
Lumens: 2140      CCT: 3000K

Luminance	
Degree	CBCP
0°	2535
5°	2489
15°	2117
25°	1342
35°	539
45°	205