

SD6DR / IC630

6" SD LED Downlight

JOB NAME		CATALOG NUMBER	
NOTES		TYPE	

ELECTRICAL DATA

LED Light Engine	System Wattage* @ 120V	CCT	Nominal Delivered Lumens**	Efficacy
L0	8W	3500K	750 lm	94 lm/W
L1	10W	3500K	1000 lm	102 lm/W
L2	14W	3500K	1500 lm	110 lm/W
L3	19W	3500K	2000 lm	108 lm/W
L4	23W	3500K	2500 lm	111 lm/W
L5	28W	3500K	3000 lm	110 lm/W
L6	33W	3500K	3500 lm	108 lm/W
L7	38W	3500K	4000 lm	108 lm/W

*System Wattage includes driver and LED Module consumption. | **Delivered lumen output will vary depending on CCT selection.

LED MODULE / OPTICS

- 80/90 CRI at 2700K, 3000K, 3500K, 4000K with 2 SDCM
- 70% lumen maintenance at 50,000 hours
- 30° Narrow Flood, 50° Flood or 70° Wide Flood

ELECTRICAL SYSTEM

- Dedicated voltage options of 120V, 277V or 347V must be specified in catalog code.
- Phase dimming available in 120V only
- 347V available with Osram 0-10V 1% Dimming only

FRAME CONSTRUCTION

Heavy duty galvanized steel frame with a large access junction box. ETL listed for through wiring. LED light engine and driver are accessible from above or below ceiling.

INSTALLATION

The luminaire is type Non-IC. Insulation must be kept at a minimum of 3" away from fixture. Universal mounting brackets included. Compatible with C-channel, flat bar, wood joist bar hanger and EMT. Bar hangers must be ordered separately. C-channel is recommended for T-bar ceilings. Maximum ceiling thickness is 1 1/4". Max. ambient temperature: 95°F (35°C).

REFLECTOR

Specification grade reflector with 1.2mm thickness. Architectural, discrete polished self flange standard. Optional painted white flange is available. Meets RP-1 requirements with controlled light distribution at a 50° cut off.

DIMMING

- 0-10V Dimming 1%
- Phase Dimming 120V only, Forward 1% / Reverse 5%
- EldoLED 0-10V 0.1% or 1%
- Lutron® LDE1 Hi-Lume 1% EcoSystem LED driver with Soft-on, Fade-to-Black dimming technology
- DMX512 RDM 0.1%

EMERGENCY BACKUP

External battery operates LED load of up to 7W at a minimum of 850 lumens for 90 minutes (EM7), or 20W at a minimum of 2350 lumens for 90 minutes (EM20). Available with remote or integral test switch, must specify.

LISTING/WARRANTY

- ETL listed to US and Canadian standards for damp locations.
- 5-Year Intense LED Limited Warranty

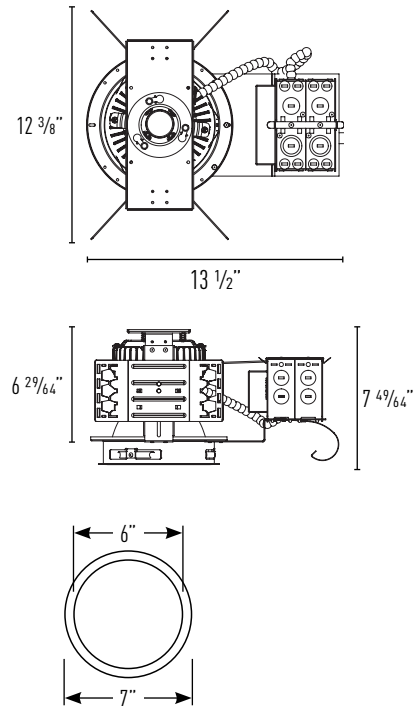

Ceiling Cut Out: 6 1/2"
Maximum Ceiling Thickness: 1 1/4"

Housing Part Number (Example: SD6DRL4359-D101-NFEM7)

Housing	LED Module	CCT / CRI	Dimming	Voltage	Optic	Options
SD6DR	L0 ¹ (8W)	27 (2700K / 80 CRI)	-D101 (Osram 0-10V 1%)	blank (120V)	-NF (30°)	EM7 (7W Emergency Backup with Remote Test Switch)
	L1 (10W)	279 (2700K / 90 CRI)	-DIM ^{3,4} (Phase Dimming)	27 (277V)	-FL (50°)	
	L2 (14W)	30 (3000K / 80 CRI)	-ED10V1 (eldoLED 0-10V 1%)	347 (347V)	-WF (70°)	EM7T (7W Emergency Unit with Integral Test Switch)
	L3 (19W)	309 (3000K / 90 CRI)	-ED10V01 (eldoLED 0-10V 0.1%)			
	L4 (23W)	35 (3500K / 80 CRI)	-LUT ⁵ (Lutron® LDE1 EcoSystem 1%)			EM20 ⁸ (20W Emergency Backup with Remote Test Switch)
	L5 (28W)	359 (3500K / 90 CRI)	-DMXR ⁶ (DMX512 RDM 0.1%)			
	L6 (33W)	40 (4000K / 80 CRI)				
L7 ² (38W)	409 (4000K / 90 CRI)					

Reflector Part Number (Example: IC630HZ-SFE,7T)

Reflector	Reflector / Flange Finish	Option
IC630	C-SF (Clear, Self-Flanged)	EM7T (Integral Test Switch)
	C-SFW (Clear, Self-Flanged White)	
	HZ-SF (Haze, Self-Flanged)	
	HZ-SFW (Haze, Self-Flanged White)	

Accessories

- I100 (C-Channel Bar Hangers)
- I200 (Flat Bar Hangers)
- I400 (Wood Joist Bar Hangers)

Notes:

- L0 only available with -D101
- 347V Not available with L7 option
- Not available in L1 or L2
- Not available in 277V
- Lutron not available in L1 & L7
- DMX512 RDM not available in L1 or L2
- 347V only available with Osram 0-10V 1% Dimming
- 20W Emergency not available in L1, L2 or L3

SD6DR / IC630

6" SD LED Downlight

JOB NAME		CATALOG NUMBER	
NOTES		TYPE	

Electrical Table					
Lumen Package	Voltage	Wattage	VA	Input Current	Power Factor
L0	120	7.43	7.99	0.07	0.930
	277	8.41	11.87	0.04	0.709
L1	120	9.75	10.37	0.09	0.94
	277	10.82	14.18	0.05	0.76
L2	120	13.71	14.35	0.12	0.96
	277	14.85	18.06	0.07	0.82
L3	120	18.27	18.54	0.15	0.99
	277	19.77	22.92	0.08	0.86
L4	120	22.74	23.04	0.19	0.99
	277	24.09	27.31	0.10	0.88
L5	120	27.18	27.44	0.23	0.99
	277	28.93	32.00	0.12	0.90
L6	120	32.76	32.84	0.27	1.00
	277	34.09	36.72	0.13	0.93
L7	120	37.71	37.79	0.31	1.00
	277	38.86	41.77	0.15	0.93

SD6DR / IC630

6" SD LED Downlight

JOB NAME		CATALOG NUMBER	
NOTES		TYPE	

SD6DRL1358 IC630C

CCT MULTIPLIERS:

	80 CRI	90 CRI
2700K	(x 0.92)	(x 0.79)
3000K	(x 0.98)	(x 0.79)
3500K	(x 1.00)	(x 0.82)
4000K	(x 1.01)	(x 0.84)

FINISH MULTIPLIERS

	30°	50°	70°
Clear	(x 1.00)	(x 1.00)	(x 1.00)
Haze	(x 0.96)	(x 0.96)	(x 0.88)
White	(x 0.96)	(x 0.97)	(x 0.90)

-NF (30° Narrow Flood)

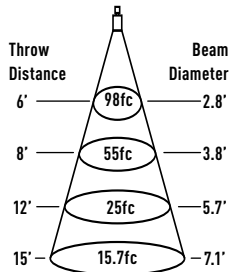

Footcandles at Nadir
Watts: 10 **LPW: 98.2**
Lumens: 982 **CCT: 3500K**

Luminance	
Degree	CBCP
0°	3536
5°	3159
15°	1491
25°	449
35°	108
45°	5

-FL (50° Flood)

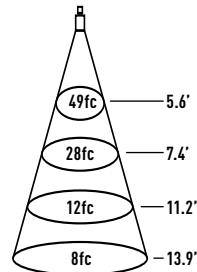

Footcandles at Nadir
Watts: 10 **LPW: 107**
Lumens: 1070 **CCT: 3500K**

Luminance	
Degree	CBCP
0°	1768
5°	1683
15°	1484
25°	879
35°	131
45°	6

-WF (70° Wide Flood)

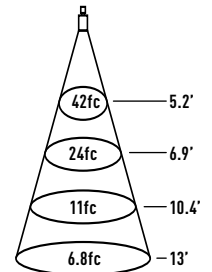

Footcandles at Nadir
Watts: 10 **LPW: 101.8**
Lumens: 1018 **CCT: 3500K**

Luminance	
Degree	CBCP
0°	1526
5°	1428
15°	1047
25°	707
35°	349
45°	45

SD6DRL2358 IC630C

CCT MULTIPLIERS:

	80 CRI	90 CRI
2700K	(x 0.92)	(x 0.79)
3000K	(x 0.98)	(x 0.79)
3500K	(x 1.00)	(x 0.82)
4000K	(x 1.01)	(x 0.84)

FINISH MULTIPLIERS

	30°	50°	70°
Clear	(x 1.00)	(x 1.00)	(x 1.00)
Haze	(x 0.96)	(x 0.96)	(x 0.88)
White	(x 0.96)	(x 0.97)	(x 0.90)

-NF (30° Narrow Flood)

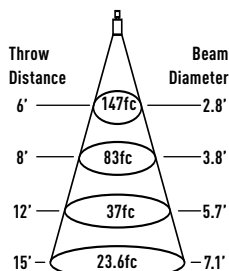

Footcandles at Nadir
Watts: 14 **LPW: 105.1**
Lumens: 1472 **CCT: 3500K**

Luminance	
Degree	CBCP
0°	5305
5°	4739
15°	2237
25°	674
35°	162
45°	8

-FL (50° Flood)

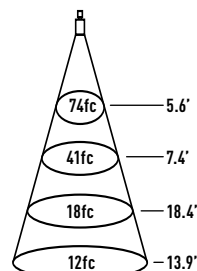

Footcandles at Nadir
Watts: 14 **LPW: 114.6**
Lumens: 1604 **CCT: 3500K**

Luminance	
Degree	CBCP
0°	2652
5°	2525
15°	2226
25°	1318
35°	196
45°	10

-WF (70° Wide Flood)

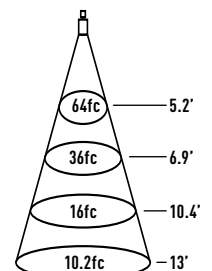

Footcandles at Nadir
Watts: 14 **LPW: 109.1**
Lumens: 1528 **CCT: 3500K**

Luminance	
Degree	CBCP
0°	2288
5°	2142
15°	1571
25°	1061
35°	524
45°	67

SD6DR / IC630

6" SD LED Downlight

JOB NAME		CATALOG NUMBER	
NOTES		TYPE	

SD6DRL3358 IC630C

CCT MULTIPLIERS:

	80 CRI	90 CRI
2700K	(x 0.92)	(x 0.79)
3000K	(x 0.98)	(x 0.79)
3500K	(x 1.00)	(x 0.82)
4000K	(x 1.01)	(x 0.84)

FINISH MULTIPLIERS

	30°	50°	70°
Clear	(x 1.00)	(x 1.00)	(x 1.00)
Haze	(x 0.96)	(x 0.96)	(x 0.88)
White	(x 0.96)	(x 0.97)	(x 0.90)

-NF (30° Narrow Flood)

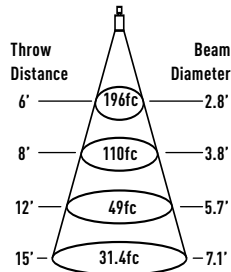

Footcandles at Nadir
 Watts: 19 LPW: 103.2
 Lumens: 1960 CCT: 3500K

Luminance	
Degree	CBCP
0°	7060
5°	6308
15°	2978
25°	896
35°	215
45°	11

-FL (50° Flood)

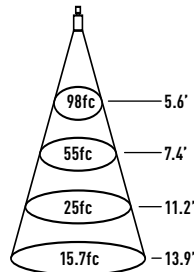

Footcandles at Nadir
 Watts: 19 LPW: 112.4
 Lumens: 2136 CCT: 3500K

Luminance	
Degree	CBCP
0°	3530
5°	3360
15°	2963
25°	1754
35°	262
45°	13

-WF (70° Wide Flood)

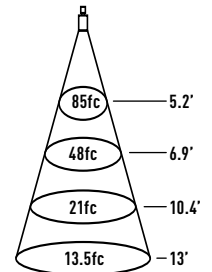

Footcandles at Nadir
 Watts: 19 LPW: 107
 Lumens: 2033 CCT: 3500K

Luminance	
Degree	CBCP
0°	3046
5°	2850
15°	2090
25°	1412
35°	697
45°	89

SD6DRL4358 IC630C

CCT MULTIPLIERS:

	80 CRI	90 CRI
2700K	(x 0.92)	(x 0.79)
3000K	(x 0.98)	(x 0.79)
3500K	(x 1.00)	(x 0.82)
4000K	(x 1.01)	(x 0.84)

FINISH MULTIPLIERS

	30°	50°	70°
Clear	(x 1.00)	(x 1.00)	(x 1.00)
Haze	(x 0.96)	(x 0.96)	(x 0.88)
White	(x 0.96)	(x 0.97)	(x 0.90)

-NF (30° Narrow Flood)

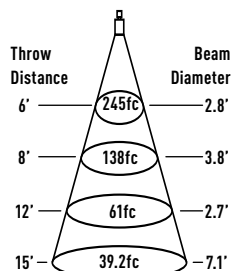

Footcandles at Nadir
 Watts: 23 LPW: 106.5
 Lumens: 2450 CCT: 3500K

Luminance	
Degree	CBCP
0°	8829
5°	7888
15°	3724
25°	1121
35°	269
45°	13

-FL (50° Flood)

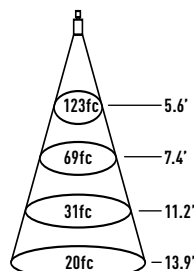

Footcandles at Nadir
 Watts: 23 LPW: 116.1
 Lumens: 2670 CCT: 3500K

Luminance	
Degree	CBCP
0°	4414
5°	4202
15°	3705
25°	2193
35°	327
45°	16

-WF (70° Wide Flood)

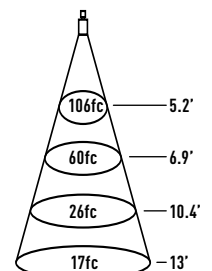

Footcandles at Nadir
 Watts: 23 LPW: 110.6
 Lumens: 2543 CCT: 3500K

Luminance	
Degree	CBCP
0°	3808
5°	3564
15°	2614
25°	1766
35°	871
45°	112