

MXFG2DRTR

3.5" MX G2 Naked LED Pinhole

ELECTRICAL DATA

LED Light Engine	System Wattage *	CCT / CRI	Delivered Lumens **	Lumens Per Watt
L0	11W	3000K / 82 CRI	850lm	85
L1	16W	3000K / 82 CRI	1200lm	75
L2	22W	3000K / 82 CRI	1450lm	73
L3	27W	3000K / 82 CRI	1600lm	62

*System Wattage include driver and LED Module consumption. **Delivered lumens will vary depending on trim, CCT, CRI, optic and ceiling thickness

FEATURES

- High center beam spot up to 24,500 CBCP
- Available optics: 12°, 24°, 36° or 50°

LED LIGHT ENGINE

- 92 CRI & 82 CRI in 2700K, 3000K, 3500K or 4100K with 2SDCM binning
- >50,000 hours L70 (rated life at 70% output)

ELECTRICAL SYSTEM

- Dedicated voltage options of 120V or 277V. Must be specified in catalog code.
- This product complies with IEEE C62.41 for surge endurance up to 2.5KV
- Additional surge protection recommended, damage from power surge is not covered by warranty

DIMMING

- 0-10V Dimming 1%
- Forward/reverse dimming 1% (120V only)
- EldoLED 0-10V 0.1% or 1%
- Lutron® LDE1 Hi-Lume 1% EcoSystem LED driver with Soft-on, Fade-to-Black dimming technology
- Lutron® LTEA2W Hi-Lume 1% 2-Wire LED driver (120V forward phase only)
- DMX512 RDM 0.1%

HOUSING

- Heavy duty galvanized 18 gauge steel frame
- Standard plaster frame accommodates 1/2" to 1-1/4" ceiling thickness
- Extended collar options available for ceilings up to 1-1/4" to 2-1/2" thick

TRIM SPECIFICATION

- A380 aluminum die-cast trims
- Durable powder coat available in multiple finishes

ACCESSORIES

- Luminaire will accommodate (2) accessories, accessory holder required, see page 2.

INSTALLATION

- Non-IC rated housings must be kept at a minimum of 3" away from insulation
- Fixture includes adjustable bar hangers (14"-24") for wood joist or t-bar ceiling installations
- Bar hangers can be installed in either direction
- Maximum ambient temperature: 95°F (35°C)

EMERGENCY BACKUP

- Remote test switch included
- External battery operates LED load at a minimum of 500lm to 850lm for 90 minutes, depending on backup wattage
- Servicing requires above ceiling access

LISTING / WARRANTY

- 5-Year Intense LED Limited Warranty
- ETL listed to US and Canadian standards for damp locations



JOB NAME	CATALOG NUMBER
NOTES	TYPE

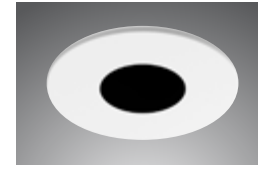

MXTFG2-RTRD306
(1-1/2" Regress)

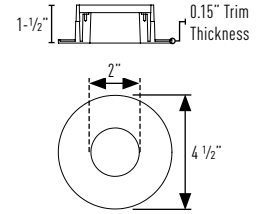

Available Trim Finishes



Housing dimensions are on Page 2

Related Products

For adjustable, wall wash and other trim options see standard MX Downtight Products



Please see [MXG2DRTR](#)
For more downtight trim options



Please see [MXG2ARTR](#)
For adjustable alternative



Please see [MXG2WRTR](#)
For wall alternative

Housing Part Number (Example: MXFG2DRTR-NCL2DELV)

Housing	Installation Type	Ceiling Thickness	Wattage	Dimming	Voltage	Options
MXFG2DRTR	-NC (Non-IC)	blank (1/2" to 1-1/4") EC2 (1-1/4" to 2-1/2")	L0 (11W)	blank (Non-Dimming)	blank (120V) 27 (277V)	EM7 ⁴ (7W Emergency Backup IOTA Part #ILB-CP07-A) EM12 ^{4,5} (12W Emergency Backup IOTA Part #ILB-CP12-A)
			L1 (16W)	DELV ¹ (Phase Dimming)		
			L2 (22W)	D101 (0-10V Dimming 1%)		
			L3 (27W)	ED10V1 ² (eldoLED 0-10V 1%) ED10V01 ² (eldoLED 0-10V 0.1%)		
				LUT ³ (Lutron® LDE1 EcoSystem 1%) LUT2 ¹ (Lutron® LTEA2W 2-Wire 1%)		

Trim Part Number (Example: MXTFG2-RTRD306WL13024)

Trim	Finish	Wattage	CCT / CRI	Optic
MXTFG2-RTRD306 (1-1/2" Regress)	B (Black)	L0 (11W)	27 (2700K / 82 CRI)	12 (12° SP)
		L1 (16W)	279 (2700K / 92 CRI)	24 (24° NFL)
	W (White)	L2 (22W)	30 (3000K / 82 CRI)	36 (36° FL)
		L3 (27W)	309 (3000K / 92 CRI)	50 (50° WFL)
			35 (3500K / 82 CRI)	
			359 (3500K / 92 CRI)	
	41 (4100K / 82 CRI)			
	419 (4100K / 92 CRI)			

Notes:

- Available in 120V only
- Not Available in L3
- Not available with L2 & L3
- Access above ceiling required
- Not available in L0
- Consult factory for lead times

SPECIFICATION SHEET L/M-040822 P-17

INTENSE LIGHTING | 3340 E La Palma Ave, Anaheim, CA 92806 | tel 714 630-9877 | fax 714 630-9883

For Intense Lighting's limited product warranty, go to www.intenselighting.com. For a printed copy of the warranty, you may call 800 961-5321.

© 2022 Intense Lighting, LLC. All rights reserved. Note: This document is subject to change without notice.

Accessories

- LH47 (Accessory Holder, Black)
- LH47W (Accessory Holder, White)
- PFLMB-47 (Hex Louver, Black)
- PFL1-47 (Prismatic Spread Lens)
- PFL2-47 (Linear Spread Lens)
- PFL4-47 (Soft Focus Lens)

MXFG2DRTR

3.5" MX G2 Naked LED Downlight

HOUSING DIMENSIONS

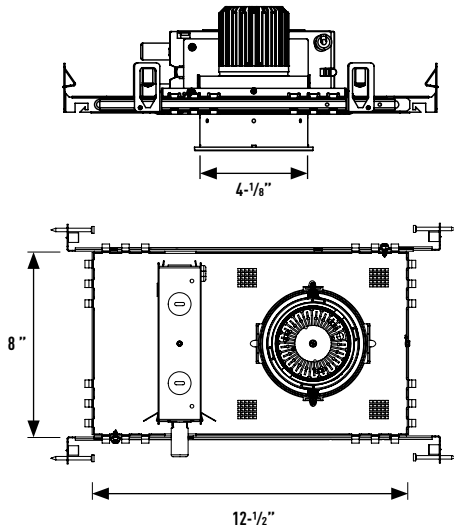

Adjustable Collar Height

Collar Type	Standard	EC2
Max Ceiling Thickness	1/2" to 1-1/4"	1-1/4" to 2-1/2"

JOB NAME	CATALOG NUMBER
NOTES	TYPE

L0-L1 Lumen Package

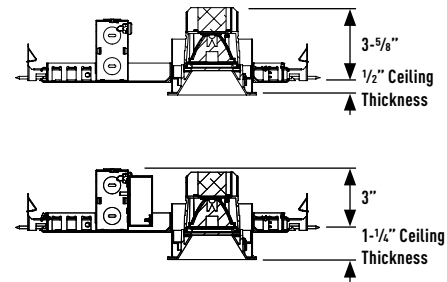

L2-L3 Lumen Package

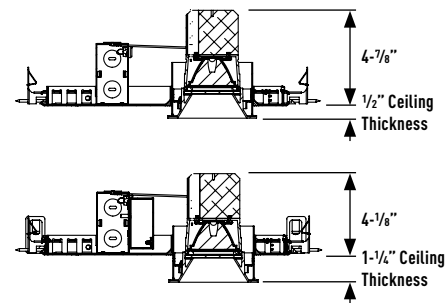

ACCESSORIES:

Luminaire will accommodate (2) accessories, accessory holder required.

INSTALLATION:

1. Rotate release cap by turning counter clockwise.
2. Install accessories into accessory holder and replace accessory holder's retaining clip.
3. Place accessory holder and accessory flush against optic and replace release cap.

Accessories

LH47	(Accessory Holder, Black)
LH47W	(Accessory Holder, White)
PFLMB-47	(Hex Louver, Black)
PFL1-47	(Prismatic Spread Lens)
PFL2-47	(Linear Spread Lens)
PFL4-47	(Soft Focus Lens)

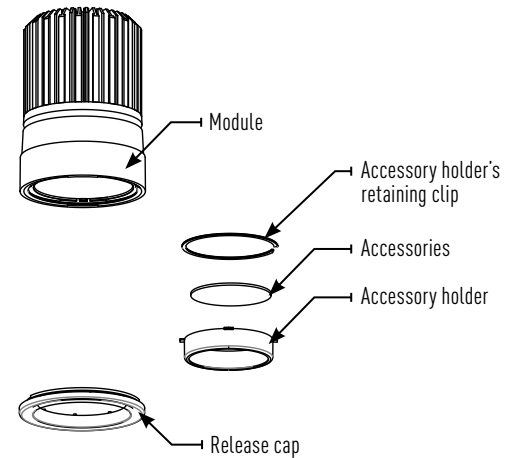

JOB NAME		CATALOG NUMBER	
NOTES		TYPE	

MXTFG2-RTRD306L0

Report #: ILL-01262016-38 (12)
 ILL-02082016-11 (24)
 ILL-01262016-44 (36)
 ILL-01262016-47 (50)

MXTFG2-RTRD306

Ceiling Thickness Multipliers:
 5/8" Thickness (x 1.00)
 1" Thickness (x 0.86)
 2" Thickness (x 0.73)

MXTFG2-RTRR306

Ceiling Thickness Multipliers:
 5/8" Thickness (x 0.98)
 1" Thickness (x 0.80)
 2" Thickness (x 0.65)

CCT MULTIPLIERS:

	82 CRI	92 CRI
2700K	(x 0.93)	(x 0.76)
3000K	(x 1.00)	(x 0.87)
3500K	(x 1.00)	(x 0.87)
4100K	(x 1.00)	(x 0.87)

EMERGENCY MULTIPLIER:

7W Emergency (x 0.70)

12° Spot (12)

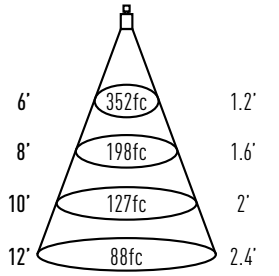

Watts: 11.3
 Lumens: 725
 LPW: 73
 CCT: 3000K

Candelas at Nadir

Degree	CBCP
0°	12674
5°	7407
15°	524
25°	50
35°	9
45°	3

24° Narrow Flood (24)

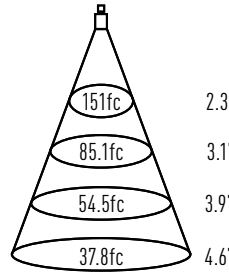

Watts: 11.3
 Lumens: 835
 LPW: 83
 CCT: 3000K

Candelas at Nadir

Degree	CBCP
0°	5449
5°	4890
15°	1255
25°	93
35°	8
45°	3

36° Flood (36)

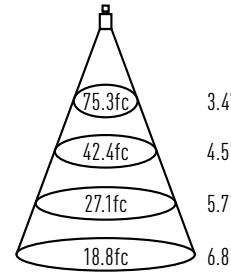

Watts: 11.3
 Lumens: 848
 LPW: 85
 CCT: 3000K

Candelas at Nadir

Degree	CBCP
0°	2712
5°	2745
15°	1555
25°	314
35°	31
45°	3

50° Wide Flood (50)

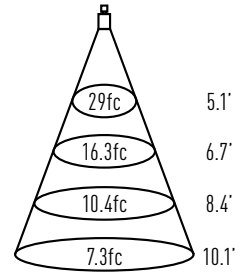

Watts: 11.3
 Lumens: 676
 LPW: 68
 CCT: 3000K

Candelas at Nadir

Degree	CBCP
0°	1043
5°	1102
15°	969
25°	469
35°	124
45°	7

MXTFG2-RTRD306L1

Report #: ILL-01262016-14 (12)
 ILL-02082016-09 (24)
 ILL-01262016-20 (36)
 ILL-01262016-23 (50)

MXTFG2-RTRD306

Ceiling Thickness Multipliers:
 5/8" Thickness (x 1.00)
 1" Thickness (x 0.86)
 2" Thickness (x 0.73)

MXTFG2-RTRR306

Ceiling Thickness Multipliers:
 5/8" Thickness (x 0.98)
 1" Thickness (x 0.80)
 2" Thickness (x 0.65)

CCT MULTIPLIERS:

	82 CRI	92 CRI
2700K	(x 0.93)	(x 0.76)
3000K	(x 1.00)	(x 0.87)
3500K	(x 1.00)	(x 0.87)
4100K	(x 1.00)	(x 0.87)

EMERGENCY MULTIPLIER:

7W Emergency (x 0.50)
 12W Emergency (x 0.85)

12° Spot (12)

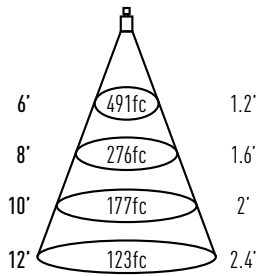

Watts: 16
 Lumens: 996
 LPW: 64
 CCT: 3000K

Candelas at Nadir

Degree	CBCP
0°	17685
5°	10155
15°	718
25°	69
35°	13
45°	4

24° Narrow Flood (24)

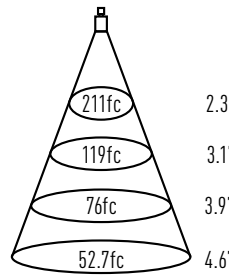

Watts: 16
 Lumens: 1165
 LPW: 75
 CCT: 3000K

Candelas at Nadir

Degree	CBCP
0°	7595
5°	6824
15°	1751
25°	129
35°	11
45°	4

36° Flood (36)

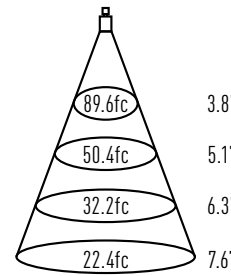

Watts: 16
 Lumens: 1204
 LPW: 77
 CCT: 3000K

Candelas at Nadir

Degree	CBCP
0°	3225
5°	3213
15°	2123
25°	569
35°	80
45°	3

50° Wide Flood (50)

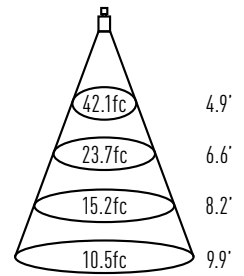

Watts: 16
 Lumens: 945
 LPW: 61
 CCT: 3000K

Candelas at Nadir

Degree	CBCP
0°	1517
5°	1599
15°	1376
25°	645
35°	166
45°	10

JOB NAME		CATALOG NUMBER	
NOTES		TYPE	

MXTFG2-RTRD306L2

Report #: ILL-01262016-26 (12)
 ILL-02082016-06 (24)
 ILL-01262016-32 (36)
 ILL-02082016-05 (50)

MXTFG2-RTRD306

Ceiling Thickness Multipliers:
 5/8" Thickness (x 1.00)
 1" Thickness (x 0.86)
 2" Thickness (x 0.73)

MXTFG2-RTRR306

Ceiling Thickness Multipliers:
 5/8" Thickness (x 0.98)
 1" Thickness (x 0.80)
 2" Thickness (x 0.65)

CCT MULTIPLIERS:

	82 CRI	92 CRI
2700K	(x 0.93)	(x 0.76)
3000K	(x 1.00)	(x 0.87)
3500K	(x 1.00)	(x 0.87)
4100K	(x 1.00)	(x 0.87)

EMERGENCY MULTIPLIER:

7W Emergency (x 0.40)
 12W Emergency (x 0.68)

12° Spot (12)

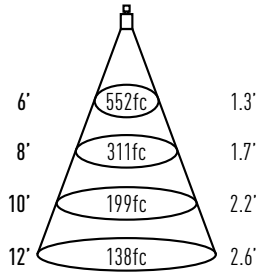

Watts: 21.5
 Lumens: 1225
 LPW: 60
 CCT: 3000K

Candelas at Nadir

Degree	CBCP
0°	19887
5°	12965
15°	776
25°	98
35°	17
45°	4

24° Narrow Flood (24)

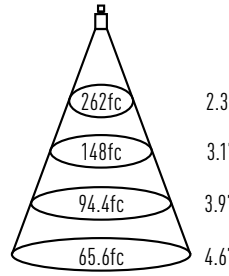

Watts: 20.8
 Lumens: 1425
 LPW: 69
 CCT: 3000K

Candelas at Nadir

Degree	CBCP
0°	9443
5°	8622
15°	2133
25°	133
35°	14
45°	5

36° Flood (36)

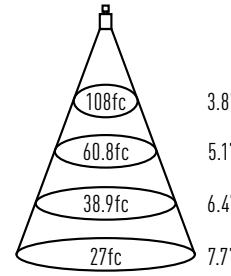

Watts: 21.5
 Lumens: 1450
 LPW: 71
 CCT: 3000K

Candelas at Nadir

Degree	CBCP
0°	3888
5°	3833
15°	2558
25°	680
35°	100
45°	4

50° Wide Flood (50)

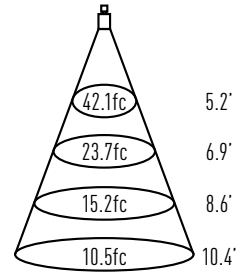

Watts: 20.8
 Lumens: 1153
 LPW: 55
 CCT: 3000K

Candelas at Nadir

Degree	CBCP
0°	1516
5°	1602
15°	1553
25°	844
35°	257
45°	17

MXTFG2-RTRD306L3

Report #: ILL-01262016-11 (12)
 ILL-02082016-02 (24)
 ILL-01262016-02 (36)
 ILL-02082016-01 (50)

MXTFG2-RTRD306

Ceiling Thickness Multipliers:
 5/8" Thickness (x 1.00)
 1" Thickness (x 0.86)
 2" Thickness (x 0.73)

MXTFG2-RTRR306

Ceiling Thickness Multipliers:
 5/8" Thickness (x 0.98)
 1" Thickness (x 0.80)
 2" Thickness (x 0.65)

CCT MULTIPLIERS:

	82 CRI	92 CRI
2700K	(x 0.93)	(x 0.76)
3000K	(x 1.00)	(x 0.87)
3500K	(x 1.00)	(x 0.87)
4100K	(x 1.00)	(x 0.87)

EMERGENCY MULTIPLIER:

7W Emergency (x 0.35)
 12W Emergency (x 0.59)

12° Spot (12)

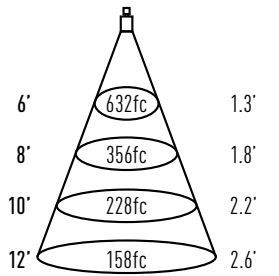

Watts: 27.2
 Lumens: 1413
 LPW: 54
 CCT: 3000K

Candelas at Nadir

Degree	CBCP
0°	22755
5°	14920
15°	840
25°	103
35°	21
45°	5

24° Narrow Flood (24)

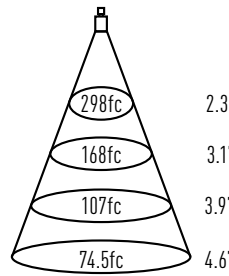

Watts: 27.2
 Lumens: 1621
 LPW: 62
 CCT: 3000K

Candelas at Nadir

Degree	CBCP
0°	10730
5°	9793
15°	2426
25°	152
35°	16
45°	6

36° Flood (36)

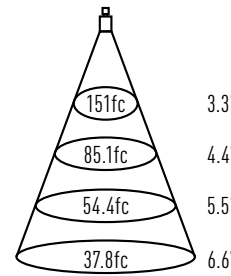

Watts: 27.2
 Lumens: 1627
 LPW: 62
 CCT: 3000K

Candelas at Nadir

Degree	CBCP
0°	5444
5°	5349
15°	2905
25°	593
35°	79
45°	6

50° Wide Flood (50)

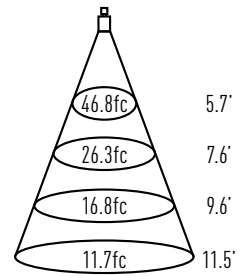

Watts: 27.2
 Lumens: 1203
 LPW: 46
 CCT: 3000K

Candelas at Nadir

Degree	CBCP
0°	1683
5°	1639
15°	1485
25°	880
35°	322
45°	28