

MXFG2DSTR

3.5" MX G2 Naked Warm Dim Square Lensed Downlight

JOB NAME		CATALOG NUMBER	
NOTES		TYPE	

ELECTRICAL DATA

LED Light Engine	System Wattage *	CCT / CRI	Delivered Lumens **	Lumens Per Watt
WD1	13.5W	3000K-1800K / 92 CRI	900lm	66 lm/W
WD2	16.5W	3000K-1800K / 92 CRI	1150lm	70 lm/W

* System Wattage include driver and LED Module consumption.

** Delivered lumens will vary depending on trim, CCT, CRI, optic and ceiling thickness

FEATURES

- Halogen style profile that warms as it dims 3000K at full intensity to 1800K at lowest dim level

LED LIGHT ENGINE

- 3000K to 1800K programmable tuning at 92 CRI
- 50,000 hours L70 (rated life at 70% output)

ELECTRICAL SYSTEM

- Multiple dimming drivers available
- 120V or 277V input; Power factor >.9, 50/60Hz
- This product complies with IEEE C62.41 for surge endurance up to 2.5KV
- Additional surge protection recommended, damage from power surge is not covered by warranty

DIMMING

- 0-10V Dimming 1%
- Forward/reverse dimming 1% (120V only)
- EldoLED 0-10V 0.1% or 1%
- Lutron® LDE1 Hi-Lume 1% EcoSystem LED driver with Soft-on, Fade-to-Black dimming technology

HOUSING

- Heavy duty galvanized 18 gauge steel frame
- Standard plaster frame accommodates 1/2" to 1-1/4" ceiling thickness
- Extended collar options available for ceilings up to 1-1/4" to 2-1/2" thick

TRIM SPECIFICATION

- A380 aluminum die-cast trims
- Durable powder coat available in multiple finishes
- Clear tempered glass standard, must specify solite
- Discrete self flange painted

INSTALLATION

- Non-IC rated housings must be kept at a minimum of 3" away from insulation
- Fixture includes adjustable bar hangers (14"-24") for wood joist or t-bar ceiling installations
- Bar hangers can be installed in either direction
- Maximum ambient temperature: 95°F (35°C)

EMERGENCY BACKUP

- Remote test switch included
- External battery operates LED load at a minimum of 500lm to 850lm for 90 minutes, depending on backup wattage selected
- Servicing requires above ceiling access

LISTING / WARRANTY

- 5-Year Intense LED Limited Warranty
- ETL listed to US and Canadian standards for wet locations

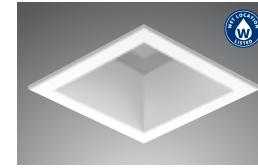

MXTFG2-STRD302
(1-1/2" Regress with Lens)

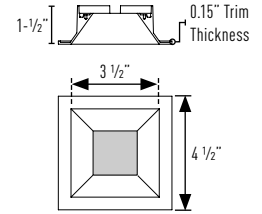

Available Trim Finishes



Housing dimensions are on Page 2

Related Products

For adjustable, wall wash and other trim options see standard MX Downlight Products

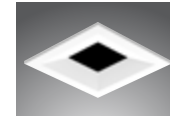

Please see [MXG2DSTR](#)
For more downlight trim options

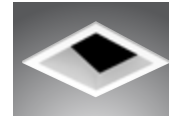

Please see [MXG2ASTR](#)
For adjustable alternative

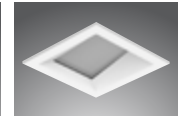

Please see [MXG2WSTR](#)
For wall alternative

Housing Part Number (Example: MXFG2DSTR-NCWD1DELV)

Housing	Installation Type	Ceiling Thickness	Wattage	Dimming	Voltage	Options
MXFG2DSTR	-NC (Non-IC)	blank (1/2" to 1-1/4")	WD1 (13.5W)	DELV ¹ (Phase Dimming)	blank (120V)	EM7 ³ (7W Emergency Backup IOTA Part #ILB-CP07-A) EM12 ³ (12W Emergency Backup IOTA Part #ILB-CP12-A)
		EC2 (1-1/4" to 2-1/2")	WD2 (16.5W)	D101 (0-10V Dimming 1%) LUT ² (Lutron® LDE1 EcoSyst™m 1%)	27 (277V)	

Trim Part Number (Example: MXTFG2-STRD302W-SFWD1NF-CR)

Trim	Trim Finish	Trim Type	Wattage	Optic	Lens
MXTFG2-STRD302 (1-1/2" Regress)	W (White)	-SF (Self Flanged)	WD1 (13.5W)	NF (24° NFL)	-CR (Clear Tempered Glass) (Solite)
	B ⁴ (Black)		WD2 (16.5W)	FL (30° FL)	
	SN ⁴ (Satin Nickel)			WF (45° WFL)	

Notes:

- Available in 120V only
- Not available with WD1
- Access above ceiling required
- Consult factory for lead times

SPECIFICATION SHEET | M-0405-23 P-10

INTENSE LIGHTING | 3340 E La Palma Ave, Anaheim, CA 92806 | tel 714 630-9877 | fax 714 630-9883

For Intense Lighting's limited product warranty, go to www.intenselighting.com. For a printed copy of the warranty, you may call 800 961-5321.

© 2023 Intense Lighting, LLC. All rights reserved. Note: This document is subject to change without notice.

MXFG2DSTR

3.5" MX G2 Naked Warm Dim Square Lensed Downlight

HOUSING DIMENSIONS

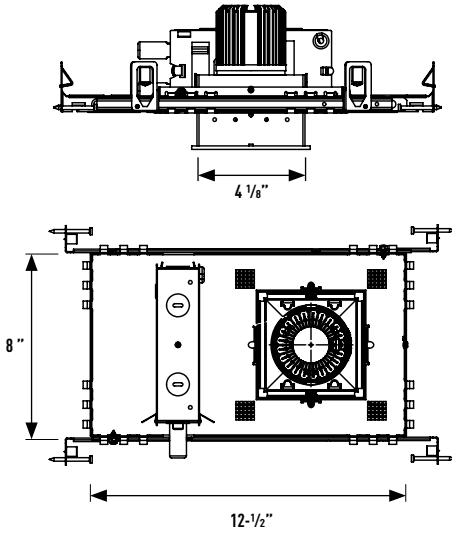

JOB NAME		CATALOG NUMBER	
NOTES		TYPE	

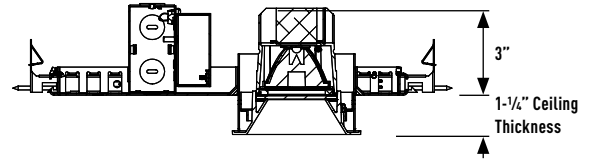
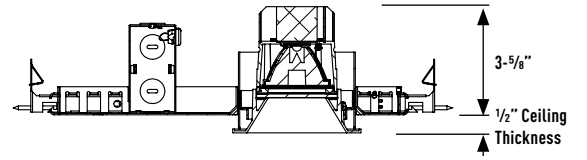

Adjustable Collar Height

Collar Type	Standard	EC2
Max Ceiling Thickness	1/2" - 1 1/4"	1 1/4" - 2 1/2"

JOB NAME		CATALOG NUMBER	
NOTES		TYPE	

MXTG2-STLD302WWD1-CR

REPORT #:
 ILL20181001-10.001 (24)
 ILL20180917-18.001 (30)
 ILL20180919-26.001 (45)

TRIM MULTIPLIERS:
 MXTG2-STRD302 (x 1.00)
 MXTG2-STRR302 (x 0.93)

LENS MULTIPLIERS:
 Solite (x 0.92)
 Clear (x 1.00)
 Frosted (x 0.92)

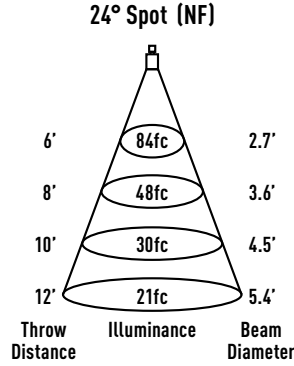

Watts: 13.5
Lumens: 699
LPW: 52
CCT: 3000K

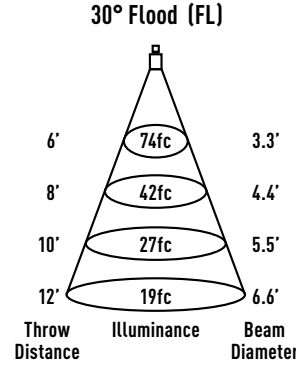

Watts: 13.5
Lumens: 855
LPW: 63
CCT: 3000K

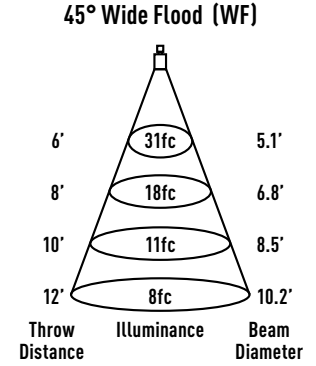

Watts: 13.5
Lumens: 743
LPW: 55
CCT: 3000K

Intensity	
Degree	Candela
0°	3039
5°	2718
15°	1069
25°	199
35°	24
45°	5

Intensity	
Degree	Candela
0°	2665
5°	2521
15°	1405
25°	386
35°	61
45°	9

Intensity	
Degree	Candela
0°	1117
5°	1093
15°	881
25°	482
35°	185
45°	49

MXTG2-STLD302WWD2-CR

REPORT #:
 ILL20181001-10.002 (24)
 ILL20180917-18.002 (30)
 ILL20180919-26.002 (45)

TRIM MULTIPLIERS:
 MXTG2-STRD302 (x 1.00)
 MXTG2-STRR302 (x 0.93)

LENS MULTIPLIERS:
 Solite (x 0.92)
 Clear (x 1.00)
 Frosted (x 0.92)

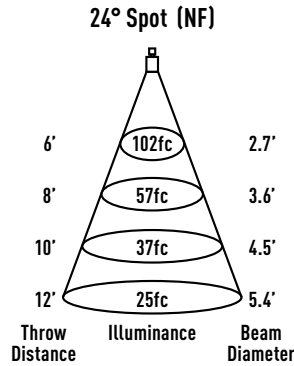

Watts: 16.4
Lumens: 842
LPW: 51
CCT: 3000K

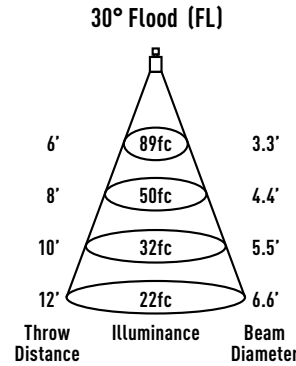

Watts: 16.4
Lumens: 1030
LPW: 63
CCT: 3000K

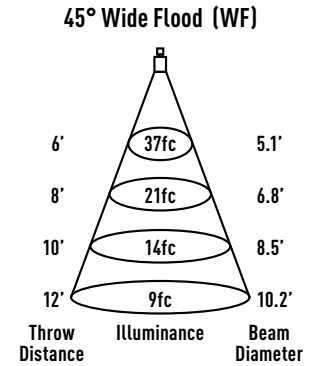

Watts: 16.4
Lumens: 895
LPW: 55
CCT: 3000K

Intensity	
Degree	Candela
0°	3661
5°	3274
15°	1289
25°	239
35°	29
45°	6

Intensity	
Degree	Candela
0°	3211
5°	3037
15°	1693
25°	465
35°	73
45°	11

Intensity	
Degree	Candela
0°	1346
5°	1317
15°	1061
25°	581
35°	223
45°	59