

MXG2DSTR

3.5" MX G2 TunableWhite Square Downlight

JOB NAME		CATALOG NUMBER	
NOTES		TYPE	

ELECTRICAL DATA

LED Light Engine	System Wattage *	CCT / CRI	Delivered Lumens **	Lumens Per Watt
TW05	8W	3500K / 92 CRI	500lm	62.5 lm/W
TW0	11W	3500K / 92 CRI	750lm	68.2 lm/W
TW1	17W	3500K / 92 CRI	1000lm	58.8 lm/W

*System Wattage includes driver and LED Module consumption. | **Delivered Lumens will vary depending on trim, CCT, CRI, optic and ceiling thickness

FEATURES

- Multiple architectural trim options
- Field changeable 14°, 26°, 30° or 45° optics

LED LIGHT ENGINE

- Tuning range from 2700K-6500K at a minimum of 92 CRI
- 3 SDCM binning throughout the tunable CCT range
- Wattage: 8W to 17W
- Rated life of >50,000 hours L70 based on LED testing per LM-80-08 and projected values using IESNA TM21-11

ELECTRICAL SYSTEM

- 120V or 277V input; Power factor >.9, 50/60Hz
- This product complies with IEEE C62.41 for surge endurance up to 2.5kV
- Additional surge protection recommended, damage from power surge is not covered by warranty

DIMMING

- eldoLED Dual Drive 2CH 0-10V 0.1% (Remote Only)
- Lutron T-Series 1% 2CH tunable white driver (Remote Only)
- DMX512 RDM 8-bit 0.1% (Remote Only)
- eldoLED Dual Drive DALI (DT6/DT8) 0.1%

HOUSING

- Heavy duty black powder coated 18 gauge steel frame
- Standard housing accommodates 5/8" ceiling thickness
- Extended collar options available for ceilings up to 1" or 2" thick, must specify either EC1 or EC2 (EC1/EC2 Not available with Chicago Plenum)

TRIM SPECIFICATION

High quality die-cast A380 aluminum trims with durable powder coat finishes. Architectural, discrete self flange or painted white flange options available. Trims available in 1-1/2" regress for greater visual comfort or 1/2" regress for consistent look throughout space.

INSTALLATION

Housing types include IC Air-Tight, CCEA (Chicago Plenum), or Non-IC Rated (must specify). Non-IC rated housings must be kept at a minimum of 3" away from insulation. Butterfly brackets are compatible with C-channel, adjustable bar hangers (14"-25") and EMT. C-channel is recommended for T-bar ceilings. Bar hangers must be ordered separately. Maximum ambient temperature: 95°F (35°C)

REMOTE BOX

- Remote box included when required by specification
- Galvanized steel construction
- Separate line voltage and low voltage wiring compartments
- 50ft remote distance maximum

ACCESSORIES

Luminaire will accommodate (2) accessories, accessory holder required.

LISTING / WARRANTY

- 5-Year Intense LED Limited Warranty
- ETL listed to US and Canadian standards for damp locations
- (-IC Only) Air-Tight Certified ASTM E283
- (-IC Only) ETL listed for direct contact w/insulation

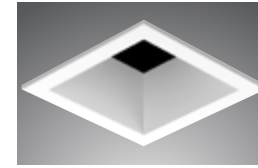

MXTG2-STRD300
(1-1/2" Regress)

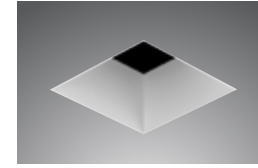
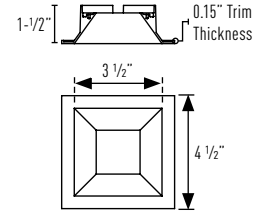

MXTG2-STLD300
(1-1/2" Regress)

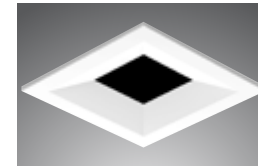
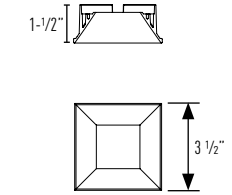

MXTG2-STRR300
(1/2" Regress)

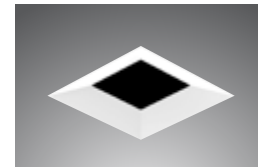
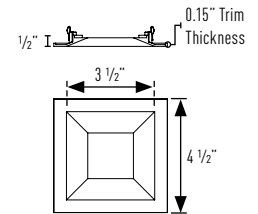

MXTG2-STLR300
(1/2" Regress)

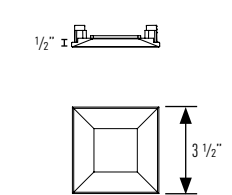

Available Trim Finishes:



Housing Part Number (Example: MXG2DSTR-ICTW05-ED10V01)

Housing Type	Ceiling Thickness	Wattage	Dimming	Voltage
MXG2DSTR-NC (Non-IC)	blank (5/8")	TW05 (8W)	-ED10V01¹ (eldoLED Dual Drive 2CH 0-10V 0.1%)	blank (Non-IC: 120V;
	EC1 (1")	TW0 (11W)	-LUTT¹ (Lutron® T Series 1%)	-IC/-CP: 120V/277V)
MXG2DSTR-IC (Air-Tight IC)	EC2 (2")	TW1 (17W)	-DMXR¹ (DMX512 RDM 8-bit 0.1%)	27 (277V Non-IC Only;
			-DALI6² (eldoLED Dual Drive DALI DT6 0.1%)	For -IC/-CP housing options use blank)
			-DALI8² (eldoLED Dual Drive DALI DT8 0.1%)	

Trim Part Number (Example: MXTG2-STRD300W-SFTWSP)

Trim	Trim Finish	Trim Type	CCT Range	Optic
MXTG2-STRD300 (1-1/2" Regress Trimmed)	W (White)	-SF (Self Flanged)	TW (2700K-6500K)	SP (14° SP)
MXTG2-STLD300³ (1-1/2" Regress Trimless)	B⁴ (Black)	-SFW⁴ (Self Flanged White)		NF (26° NFL)
	SN⁴ (Satin Nickel)	blank ³ (Trimless, for use with mud ring only)		FL (30° FL)
MXTG2-STRR300 (1/2" Regress Trimmed)	AB⁴ (Antique Bronze)			WF (45° WFL)
MXTG2-STLR300³ (1/2" Regress Trimless)	WH⁴ (Wheat)			

Notes:

- AIC only, Remote Box Required
- Not Available with AIC or CP in TW1
- Trimless options are for use with mud ring accessory only
- Consult factory for lead times

Accessories

- LH47** (Accessory Holder, Black)
- LH47W** (Accessory Holder, White)
- PFLMB-47** (Hex Louver, Black)
- PFL1-47** (Prismatic Spread Lens)
- PFL2-47** (Linear Spread Lens)
- PFL4-47** (Soft Focus Lens)

Bar Hangers

- I100** (C-Channel Bar Hangers)
- I200** (Flat Bar Hangers)
- I400** (Wood Joist Bar Hangers)

Mud Ring

- MXS-MR¹** (Square Trimless Mud Ring)

MX DOWNLIGHTING LUM-0512-21 P-21

INTENSE LIGHTING | 3340 E La Palma Ave, Anaheim, CA 92806 | tel 714 630-9877 | fax 714 630-9883

For Intense Lighting's limited product warranty, go to www.intenselighting.com. For a printed copy of the warranty, you may call 800 961-5321.

© 2021 Intense Lighting, LLC. All rights reserved. Note: This document is subject to change without notice.

MXG2DSTR

3.5" MX G2 TunableWhite Square Downlight

JOB NAME		CATALOG NUMBER	
NOTES		TYPE	

NON-IC & AIR TIGHT IC DIMENSIONS

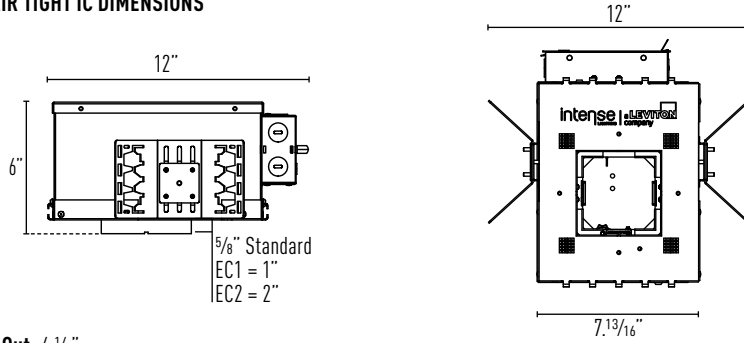

Plaster Frame Accommodation

Collar Type	Standard	EC1	EC2
Max Ceiling Thickness	Up-to 5/8"	Up-to 1"	Up-to 2"

Ceiling Cut Out: 4 1/8"

REMOTE MOUNTED DRIVER OPTIONS

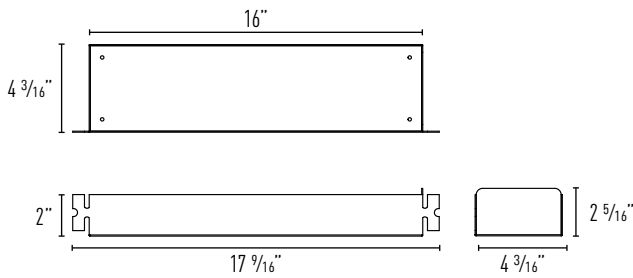

Remote Driver Box For

- eldoLED Dual Drive 2CH 0-10V 0.1%
- Lutron T-Series 1% 2CH tunable white driver
- DMX512 RDM 8-bit 0.1%

Note: Wires for class 2 LED driver require a minimum of 18 AWG wire at a maximum of 50 feet length per local and national electrical regulations.

Lumen Package	System Wattage		
	CCT	120V	277V
TW05 (500lm)	2700K	8W	10W
	3500K	8W	9W
	6000K	7W	8W
TW0 (750lm)	2700K	13W	14W
	3500K	11W	12W
	6000K	10W	12W
TW1 (1000lm)	2700K	21W	22W
	3500K	17W	18W
	6000K	16W	17W

MXG2DSTR

3.5" MX G2 TunableWhite Square Downlight

JOB NAME	CATALOG NUMBER
NOTES	TYPE

ACCESSORIES:

Luminaire will accommodate (2) accessories, accessory holder required.

INSTALLATION:

1. Rotate release cap by turning counter clockwise.
2. Install accessories into accessory holder and replace accessory holder's retaining clip.
3. Place accessory holder and accessory flush against optic and replace release cap.

Accessories

LH47	(Accessory Holder, Black)
LH47W	(Accessory Holder, White)
PFLMB-47	(Hex Louver, Black)
PFL1-47	(Prismatic Spread Lens)
PFL2-47	(Linear Spread Lens)
PFL4-47	(Soft Focus Lens)

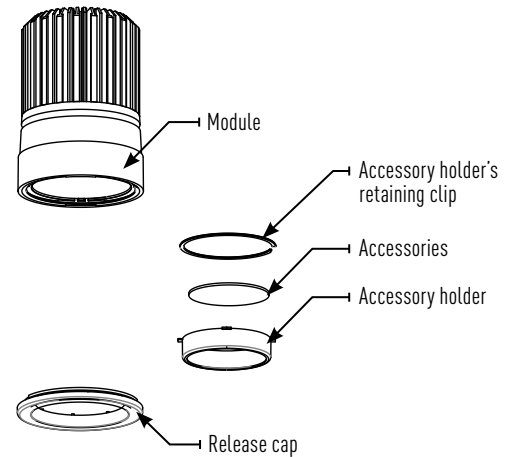

OPTICS REPLACEMENT

1. Rotate release cap by turning counter clockwise.
2. Install accessories into accessory holder and replace accessory holder's retaining clip.
3. Place accessory holder and accessory flush against optic and replace release cap.

Optics

IP-OP4712	(14° Spot)
IP-OP4724	(26° Narrow Flood)
IP-OP4736	(30° Flood)
IP-OP4750	(45° Wide Flood)

