

MXRG2DRTR

3.5" MX G2 LED Lensed Pinhole with Remodel Housing - Wet Location

JOB NAME		CATALOG NUMBER	
NOTES		TYPE	

ELECTRICAL DATA

LED Light Engine	System Wattage *	CCT / CRI	Delivered Lumens **	Lumens Per Watt
L0	10W	3000K / 82 CRI	780lm	78
L1	16W	3000K / 82 CRI	1100lm	69
L2	20W	3000K / 82 CRI	1300lm	65
L3	26W	3000K / 82 CRI	1500lm	58

*System Wattage include driver and LED Module consumption. **Delivered lumens will vary depending on trim, CCT, CRI, optic and ceiling thickness

FEATURES

- Multiple architectural trim options
- High center beam spot up to 20,900 CBCP
- Dedicated 9° with field changeable 12°, 24°, 36° & 50° optics

LED LIGHT ENGINE

- 92 CRI & 82 CRI in 2700K, 3000K, 3500K or 4100K with ZSDCM binning
- >50,000 hours L70 (rated life at 70% output)

ELECTRICAL SYSTEM

- Dedicated voltage options of 120V or 277V. Must be specified in catalog code
- Power factor >.95/60Hz This product complies with IEEE C62.41 for surge endurance up to 2.5KV. Additional surge protection recommended. Damage from power surge is not covered by warranty.

DIMMING

- 0-10V Dimming 1%
- Forward/reverse dimming 1% (120V only)
- EldoLED 0-10V 0.1% or 1%
- Lutron® LDE1 Hi-Lume 1% EcoSystem LED driver with Soft-on, Fade-to-Black dimming technology
- DMX512 RDM 0.1%

HOUSING

High quality die-casted collar with high strength stainless steel swing out lugs. Driver swivels 90° to accommodate tight spaces.

TRIM SPECIFICATION

High quality trims are die-cast using A380 aluminum and finished with durable powder coat available in multiple finishes, black interior standard. Trim is available with solite, clear tempered or frosted lens, must specify. Trims available in 1-1/2" regress for greater visual comfort or 1/2" regress for consistent look throughout space.

INSTALLATION

Frame-in installs from below the ceiling. Swing out lugs allow for installation in ceilings between 5/16" and 3/4". Max. ambient temperature: 95°F (35°C). Housing is Non-IC rated, must be kept at a minimum of 3" away from insulation.

LISTING / WARRANTY

- 5-Year Intense LED Limited Warranty
- ETL listed to US and Canadian standards for wet locations

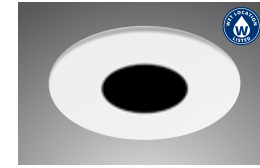

MXTG2-RTRD308
(1-1/2" regress with Lens)

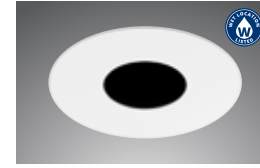
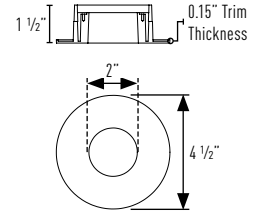

MXTG2-RFRR308
(1/2" Flat Mount with Lens)

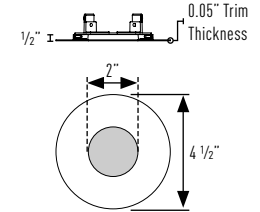

Housing Dimensions Are On Page 2

Available Trim Finishes



Housing Part Number (Example: MXG2DRTR-NCL1)

Housing	Installation Type	Wattage	Dimming	Voltage
MXG2DRTR	-NC (Non-IC)	L0 (10W)	blank (Non-Dimming)	blank (120V)
		L1 (16W)	DELV ¹ (Phase Dimming)	27 (277V)
		L2 (20W)	D101 (0-10V Dimming 1%)	
		L3 (26W)	ED10V1 ² (eldoLED 0-10V 1%)	
			ED10V01 ² (eldoLED 0-10V 0.1%)	
			LUT ³ (Lutron® LDE1 EcoSystem 1%)	
		DMXR ⁴ (DMX512 RDM 0.1%)		

Trim Part Number (Example: MXTG2-RTRD308WL13024-SL)

Trim	Finish	Wattage	CCT / CRI	Optic	Lens
MXTG2-RTRD308 (1-1/2" regress)	W (White)	L0 (10W)	27 (2700K / 82 CRI)	09 ⁴ (9° Narrow Spot)	-SL (Solite)
	B (Black)	L1 (16W)	279 (2700K / 92 CRI)	12 (12° Spot)	-CR (Clear Tempered)
MXTG2-RFRR308 (1/2" Flat Mount)	AB (Antique Bronze)	L2 (20W)	30 (3000K / 82 CRI)	24 (24° Narrow Flood)	-FR (Frosted)
		L3 (26W)	309 (3000K / 92 CRI)	36 (36° Flood)	
			35 (3500K / 82 CRI)	50 (50° Wide Flood)	
			359 (3500K / 92 CRI)		
			41 (4100K / 82 CRI)		
	419 (4100K / 92 CRI)				

Notes:

- Available in 120V only
- Not Available in L3
- Not Available in L2 & L3
- DMX512 RDM not available in L0 & L1
- 9° NS available in 279 with L0 or L1 Only

MX DOWNLIGHTING REMODEL L/M-1005:23 P-13

INTENSE LIGHTING | 3340 E La Palma Ave, Anaheim, CA 92806 | tel 714 630-9877 | fax 714 630-9883

For Intense Lighting's limited product warranty, go to www.intenselight.com. For a printed copy of the warranty, you may call 800 961-5321.

© 2023 Intense Lighting, LLC. All rights reserved. Note: This document is subject to change without notice.

MXRG2DRTR

3.5" MX G2 LED Lensed Pinhole with Remodel Housing - Wet Location

JOB NAME	CATALOG NUMBER
NOTES	TYPE

DRIVER: Non-Dimming / DELV / D10

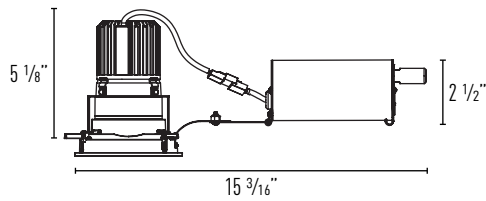

Ceiling Cut Out: 4 1/8"
Minimum Ceiling Thickness: 5/16"
Maximum Ceiling Thickness: 3/4"

DRIVER: eldoLED / Lutron / DMX

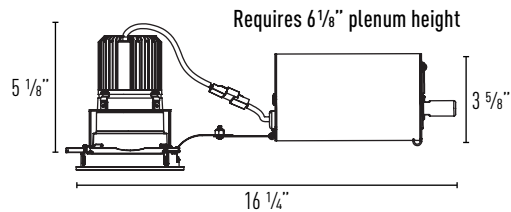

Ceiling Cut Out: 4 1/8"
Minimum Ceiling Thickness: 5/16"
Maximum Ceiling Thickness: 3/4"

OPTICS REPLACEMENT

1. Rotate release cap by turning counter clockwise.
2. Install accessories into accessory holder and replace accessory holder's retaining clip.
3. Place accessory holder and accessory flush against optic and replace release cap.

Optics

- IP-OP4712 (12° Spot)
- IP-OP4724 (24° Narrow Flood)
- IP-OP4736 (36° Flood)
- IP-OP4750 (50° Wide Flood)

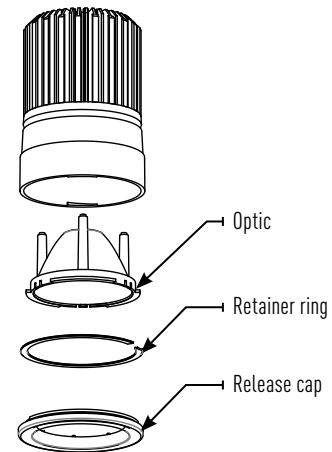

JOB NAME		CATALOG NUMBER	
NOTES		TYPE	

MXTG2-RTRD308L0-CR

Report #: ILL-01262016-38 (12)
 ILL-02082016-11 (24)
 ILL-01262016-44 (36)
 ILL-01262016-47 (50)

TRIM MULTIPLIER:
 MXTG2-RFRR308 (x 0.98)

CCT MULTIPLIERS:
82 CRI 92 CRI
 2700K (x 0.93) (x 0.76)
 3000K (x 1.00) (x 0.87)
 3500K (x 1.00) (x 0.87)
 4100K (x 1.00) (x 0.87)

LENS MULTIPLIERS:
 Solite (x 0.92)
 Clear (x 1.00)
 Frosted (x 0.92)

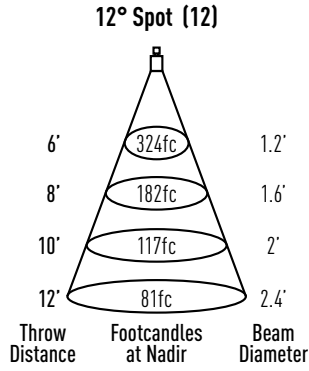

Watts: 10
 Lumens: 667
 LPW: 67
 CCT: 3000K

Candelas at Nadir

Degree	CBCP
0°	11660
5°	6814
15°	482
25°	46
35°	8
45°	2

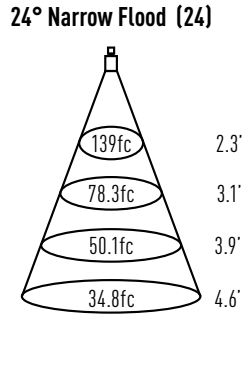

Watts: 10
 Lumens: 768
 LPW: 77
 CCT: 3000K

Candelas at Nadir

Degree	CBCP
0°	5013
5°	4499
15°	1155
25°	85
35°	7
45°	3

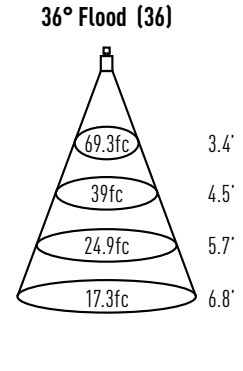

Watts: 10
 Lumens: 780
 LPW: 78
 CCT: 3000K

Candelas at Nadir

Degree	CBCP
0°	2495
5°	2526
15°	1430
25°	289
35°	29
45°	2

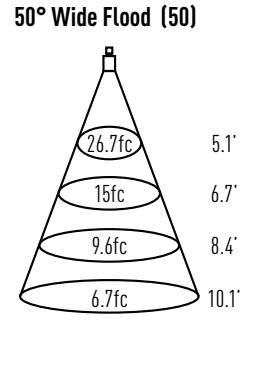

Watts: 10
 Lumens: 622
 LPW: 62
 CCT: 3000K

Candelas at Nadir

Degree	CBCP
0°	960
5°	1014
15°	892
25°	431
35°	114
45°	7

MXTG2-RTRD308L1-CR

Report #: ILL-01262016-14 (12)
 ILL-02082016-09 (24)
 ILL-01262016-20 (36)
 ILL-01262016-23 (50)

TRIM MULTIPLIER:
 MXTG2-RFRR308 (x 0.98)

CCT MULTIPLIERS:
82 CRI 92 CRI
 2700K (x 0.93) (x 0.76)
 3000K (x 1.00) (x 0.87)
 3500K (x 1.00) (x 0.87)
 4100K (x 1.00) (x 0.87)

LENS MULTIPLIERS:
 Solite (x 0.92)
 Clear (x 1.00)
 Frosted (x 0.92)

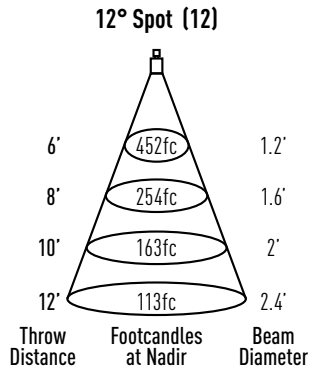

Watts: 15.4
 Lumens: 916
 LPW: 59
 CCT: 3000K

Candelas at Nadir

Degree	CBCP
0°	16271
5°	9342
15°	661
25°	63
35°	12
45°	3

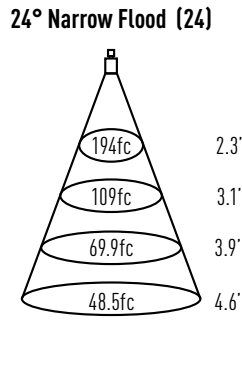

Watts: 15.6
 Lumens: 1072
 LPW: 69
 CCT: 3000K

Candelas at Nadir

Degree	CBCP
0°	6988
5°	6278
15°	1611
25°	119
35°	10
45°	4

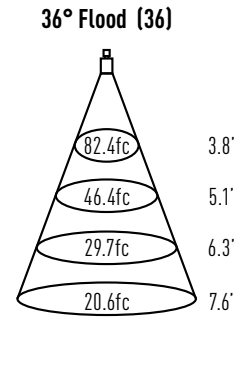

Watts: 15.4
 Lumens: 1108
 LPW: 71
 CCT: 3000K

Candelas at Nadir

Degree	CBCP
0°	2967
5°	2956
15°	1953
25°	523
35°	74
45°	3

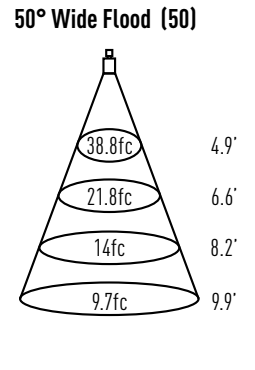

Watts: 15.6
 Lumens: 870
 LPW: 56
 CCT: 3000K

Candelas at Nadir

Degree	CBCP
0°	1396
5°	1471
15°	1266
25°	594
35°	153
45°	9

JOB NAME		CATALOG NUMBER	
NOTES		TYPE	

MXTG2-RTRD308L0-CR

Report #: ILL-01262016-38 (12)
 ILL-02082016-11 (24)
 ILL-01262016-44 (36)
 ILL-01262016-47 (50)

TRIM MULTIPLIER:
 MXTG2-RFRR308 (x 0.98)

CCT MULTIPLIERS:
82 CRI 92 CRI
 2700K (x 0.93) (x 0.76)
 3000K (x 1.00) (x 0.87)
 3500K (x 1.00) (x 0.87)
 4100K (x 1.00) (x 0.87)

LENS MULTIPLIERS:
 Solite (x 0.92)
 Clear (x 1.00)
 Frosted (x 0.92)

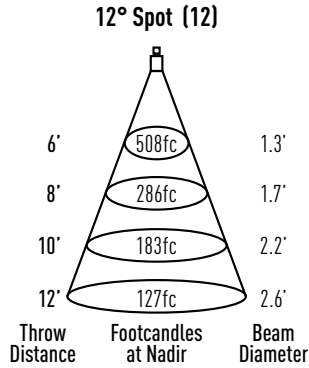

Watts: 20.4
 Lumens: 1127
 LPW: 55
 CCT: 3000K

Candelas at Nadir

Degree	CBCP
0°	18296
5°	11928
15°	714
25°	90
35°	16
45°	4

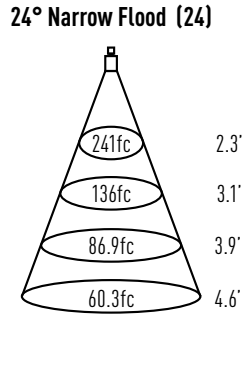

Watts: 20.8
 Lumens: 1311
 LPW: 63
 CCT: 3000K

Candelas at Nadir

Degree	CBCP
0°	8688
5°	7933
15°	1963
25°	123
35°	13
45°	4

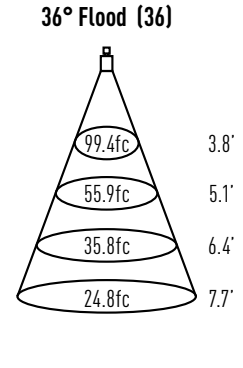

Watts: 20.4
 Lumens: 1334
 LPW: 65
 CCT: 3000K

Candelas at Nadir

Degree	CBCP
0°	3577
5°	3527
15°	2353
25°	626
35°	92
45°	4

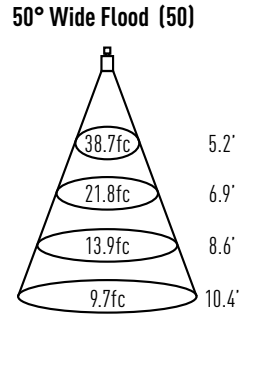

Watts: 20.8
 Lumens: 1061
 LPW: 51
 CCT: 3000K

Candelas at Nadir

Degree	CBCP
0°	1395
5°	1474
15°	1429
25°	777
35°	236
45°	15

MXTG2-RTRD308L3-CR

Report #: ILL-01262016-11 (12)
 ILL-02082016-02 (24)
 ILL-01262016-02 (36)
 ILL-02082016-01 (50)

TRIM MULTIPLIER:
 MXTG2-RFRR308 (x 0.98)

CCT MULTIPLIERS:
82 CRI 92 CRI
 2700K (x 0.93) (x 0.76)
 3000K (x 1.00) (x 0.87)
 3500K (x 1.00) (x 0.87)
 4100K (x 1.00) (x 0.87)

LENS MULTIPLIERS:
 Solite (x 0.92)
 Clear (x 1.00)
 Frosted (x 0.92)

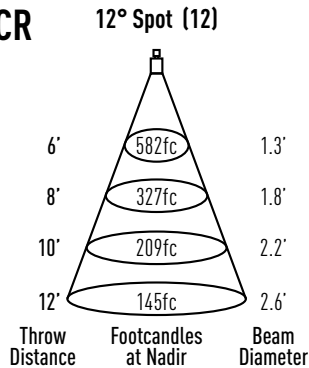

Watts: 26.3
 Lumens: 1300
 LPW: 49
 CCT: 3000K

Candelas at Nadir

Degree	CBCP
0°	20935
5°	13727
15°	773
25°	95
35°	19
45°	5

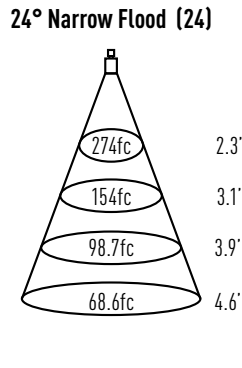

Watts: 26.3
 Lumens: 1491
 LPW: 57
 CCT: 3000K

Candelas at Nadir

Degree	CBCP
0°	9871
5°	9010
15°	2232
25°	140
35°	15
45°	5

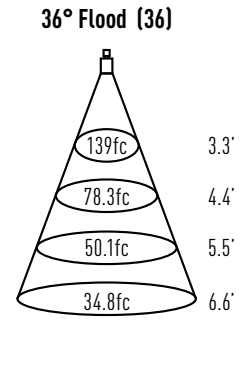

Watts: 26.4
 Lumens: 1497
 LPW: 57
 CCT: 3000K

Candelas at Nadir

Degree	CBCP
0°	5008
5°	4921
15°	2673
25°	545
35°	72
45°	5

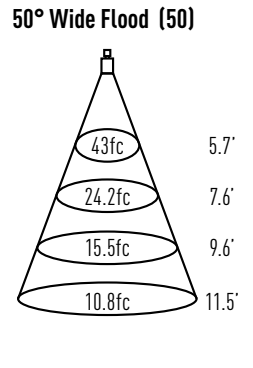

Watts: 26.3
 Lumens: 1107
 LPW: 42
 CCT: 3000K

Candelas at Nadir

Degree	CBCP
0°	1548
5°	1508
15°	1366
25°	809
35°	296
45°	26