

# GC6DRREM

## 6" Gravity LED Downlight Cylinder With Remote Driver Enclosure

JOB NAME		CATALOG NUMBER	
NOTES		TYPE	

### ELECTRICAL DATA: (Data Based On 3000K/82CRI Configuration)

LED Light Engine	Nominal Delivered Lumens *	System Wattage **	Efficacy	LED Light Engine	Nominal Delivered Lumens *	System Wattage **	Efficacy
L1	1000lm	9W	111 lm/W	L7	4000lm	34W	118 lm/W
L2	1500lm	11W	136 lm/W	L8	4500lm	41W	109 lm/W
L3	2000lm	13W	154 lm/W	L9	5000lm	47W	106 lm/W
L4	2500lm	17W	147 lm/W	L10	6000lm	49W	122 lm/W
L5	3000lm	22W	136 lm/W	L11	7000lm	58W	121 lm/W
L6	3500lm	28W	125 lm/W				

\* Delivered lumen output will vary depending on CCT, CRI, optic and reflector finish. | \*\* System Wattage include driver and LED Module consumption.

### FEATURES

- High performance cylinder extruded from aluminum in durable powder coat finishes
- Control protocols from ELV, 0-10V, 2-Wire, DALI and DMX with options available in 0.1% and dim-to-dark

### LED LIGHT ENGINE

- 82/92 CRI, 2700K, 3000K, 3500K or 4000K
- 2 Step MacAdam (2 SDCM)
- Rated life of >50,000 hours L70 based on LED testing per LM-80-08 and projected values using IESNA TM21-11

### DIMMING

- Forward/Reverse Phase Dimming 5% (120V only)
- 0-10V Dimming 1%
- eldoLED 0-10V 0.1% or 1%
- Lutron® LDE1 Hi-Lume 1% EcoSystem LED driver with Soft-on, Fade-to-Black dimming technology
- DMX512 RDM 0.1%

### OPTICS

- 14° Narrow Spot, 20° Spot, 30° Narrow Flood, 40° Flood, 50° Wide Flood and 60° Very Wide Flood
- Optics and filter media are field interchangeable

### ELECTRICAL SYSTEM

- 120V-277V Power factor >.9, 50/60Hz
- 347V available, consult factory
- Multiple dimming drivers available
- This product complies with IEEE C62.41 for surge endurance up to 2.5KV. Additional surge protection recommended. Damage from power surge is not covered by warranty.

### EMERGENCY BACKUP

Remote test switch included. External battery operates LED load of up to 7W at a minimum of 400 lumens for 90 minutes (EM7), or 20W at a minimum of 1200 lumens for 90 minutes (EM20).

### REFLECTOR

Specification grade reflector with 1.5mm thickness. Reflector available in black, clear specular, haze or white. Meets RP-1 requirements with controlled light distribution at a 55° cut off.

### REMOTE DRIVER ENCLOSURE

- Galvanized steel construction
- 50ft remote distance maximum

### ACCESSORIES

Luminaire accepts (1) media filter and (1) hex cell louver.

### MOUNTING

- Surface mount for direct installation to 3" or 4" Octagonal J-Box.
- 144" Aircraft cable is supplied with canopy assembly
- Pendant stems supplied with complete canopy assembly.
- Supplied aircraft cables and slope pendant stems are cuttable and can be modified in the field.

### LISTING / WARRANTY

- ETL Listed to US and Canadian standards for damp locations
- 5-Year Intense LED Limited Warranty



Gravity™



Dimension are on Page 2

### Accessories

- PFL2-111 (Linear Spread)
- PFL4-111 (Solite Soft Focus Lens)
- PFLMB-111 (Black Hex Louver)

### Cylinder Part Number (Example: GC6DRREML527-NSWWC144)

Cylinder	Wattage	CCT / CRI	Optic	Cylinder Finish	Reflector Finish	Mounting	
GC6DRREM	L1 <sup>1</sup> (10W)	L7 (36W)	27 (2700K/82CRI)	-NS <sup>4</sup> (14° Narrow Spot)	W (White)	W (White)	C144 (144" Aircraft Cable)
	L2 <sup>1</sup> (12W)	L8 (43W)	279 (2700K/92 CRI)	-SP (20° Spot)	B (Black)	HZ (Haze)	P12 (12" Slope Pendant)
	L3 (14W)	L9 (49W)	30 (3000K/82 CRI)	-NF (30° Narrow Flood)	SV (Silver)	C (Clear)	P24 (24" Slope Pendant)
	L4 (18W)	L10 (50W)	309 (3000K/92 CRI)	-FL (40° Flood)		B <sup>9</sup> (Black)	P36 <sup>10</sup> (36" Slope Pendant)
	L5 (23W)	L11 (60W)	35 (3500K/82 CRI)	-WF <sup>7</sup> (50° Wide Flood)			P48 (48" Slope Pendant)
	L6 (30W)		359 (3500K/92 CRI)	-VF <sup>8</sup> (60° Very Wide Flood)			P96 <sup>11</sup> (96" Slope Pendant)
			40 (4000K/82 CRI)				S (Surface)
		409 (4000K/92 CRI)					

### Remote Emergency Power Box (Example: REMGC6L1EM20)

Power Box	LED Light Engine	Dimming	Emergency Back Up
REMG6C	L1 <sup>1</sup> (10W)	L7 (36W)	EM7 (7W Emergency Backup w/ Remote Test Switch <a href="#">IOTA part #ILB-CP07-A</a> )
	L2 <sup>1</sup> (12W)	L8 (43W)	
	L3 (14W)	L9 (49W)	EM20 <sup>12</sup> (20W Emergency Backup w/ Remote Test Switch <a href="#">IOTA ILB-CP20-HE-A</a> )
	L4 (18W)	L10 (50W)	
	L5 (23W)	L11 (60W)	
	L6 (30W)		

### Notes:

- L1 & L2 only available with -D101
- eldoLED dimming available with L3-L10
- Lutron® dimming available with L3-L8
- Available in 120V only
- DMX512 RDM available with L4-L10
- 14° Optic (NS) available on L1-L9 only
- Does not accept filter media accessories from L3-L9
- 60° Optic (VF) available on L10-L11 only. Does not accept filter media accessories.
- Consult factory for lead times
- Special order. Note: 36" Pendant is made with (1) 12" & 24" w/ coupler
- (2) 48" Stems with coupler
- Not available in L1 & L4

GRAVITY CYLINDERS LJM-0410/24 P-1

INTENSE LIGHTING | 3340 E La Palma Ave, Anaheim, CA 92806 | tel 714 630-9877 | fax 714 630-9883

For Intense Lighting's limited product warranty, go to [www.intenselighting.com](http://www.intenselighting.com). For a printed copy of the warranty, you may call 800 961-5321.

© 2024 Intense Lighting, LLC. All rights reserved. Note: This document is subject to change without notice.

# GC6DRREM

6" Gravity LED Downlight Cylinder With Remote Driver Enclosure

JOB NAME		CATALOG NUMBER	
NOTES		TYPE	

## Surface Mount

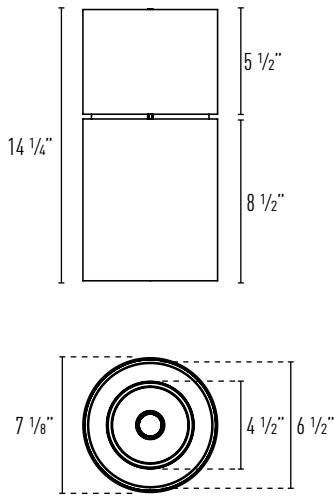

## Aircraft Cable

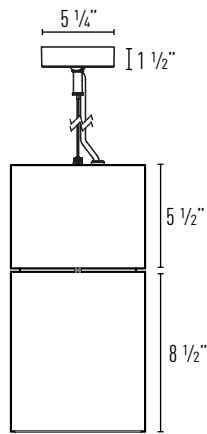

## Pendant Mount

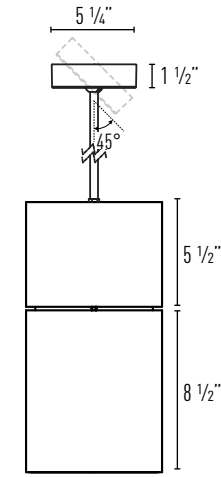

Canopy can be mounted at a maximum angle of 45°

## Remote Driver Enclosure

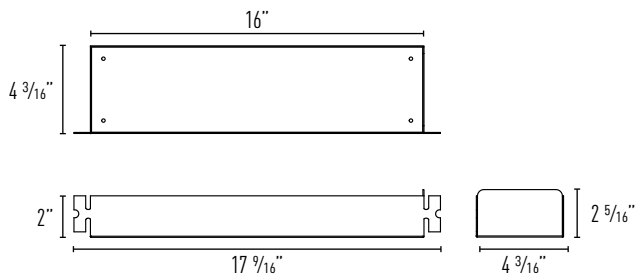

## Emergency Backup

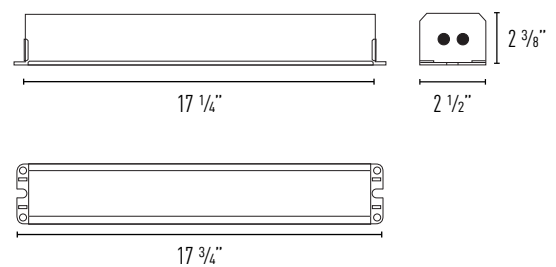

JOB NAME		CATALOG NUMBER	
NOTES		TYPE	

## GC6DRL330HZ

Report #: ILL20191216-4.001 (14)  
 ILL20191216-11.001 (20)  
 ILL20191217-7.001 (30)  
 ILL20191217-14.001 (40)  
 ILL20191218-5.001 (50)

### CCT MULTIPLIERS:

	<b>82 CRI</b>	<b>92 CRI</b>
2700K	(x 0.95)	(x 0.79)
3000K	(x 1.00)	(x 0.82)
3500K	(x 1.02)	(x 0.85)
4000K	(x 1.03)	(x 0.88)

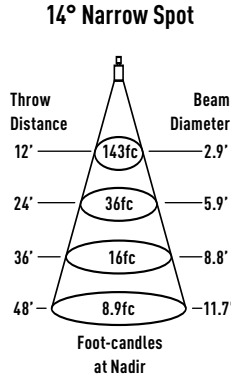

Watts: 13      LPW: 162  
 Lumens: 2112      CCT: 3000K

Intensity	
Degree	CBCP
0°	20572
5°	15552
15°	1738
25°	832
35°	46
45°	35

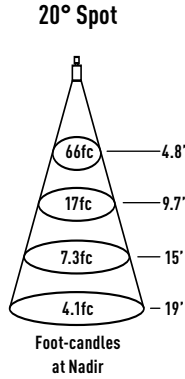

Watts: 13      LPW: 158  
 Lumens: 2053      CCT: 3000K

Intensity	
Degree	CBCP
0°	9494
5°	8077
15°	2830
25°	863
35°	70
45°	47

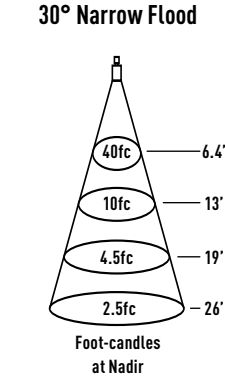

Watts: 13      LPW: 156  
 Lumens: 2031      CCT: 3000K

Intensity	
Degree	CBCP
0°	5821
5°	5453
15°	2888
25°	1219
35°	99
45°	37

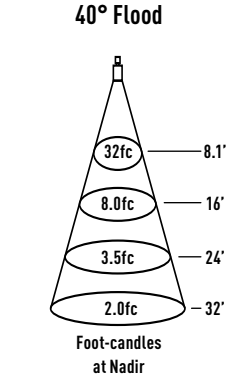

Watts: 13      LPW: 154  
 Lumens: 2005      CCT: 3000K

Intensity	
Degree	CBCP
0°	4596
5°	4405
15°	2942
25°	1301
35°	107
45°	48

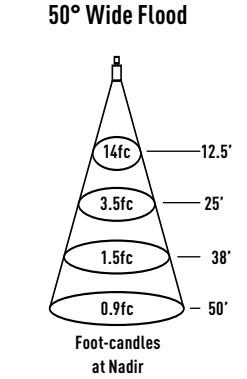

Watts: 13      LPW: 139  
 Lumens: 1806      CCT: 3000K

Intensity	
Degree	CBCP
0°	2008
5°	1965
15°	1663
25°	1167
35°	565
45°	196

## GC6DRL430HZ

Report #: ILL20191216-4.002 (14)  
 ILL20191216-11.002 (20)  
 ILL20191217-7.002 (30)  
 ILL20191217-14.002 (40)  
 ILL20191218-5.002 (50)

### CCT MULTIPLIERS:

	<b>82 CRI</b>	<b>92 CRI</b>
2700K	(x 0.95)	(x 0.79)
3000K	(x 1.00)	(x 0.82)
3500K	(x 1.02)	(x 0.85)
4000K	(x 1.03)	(x 0.88)

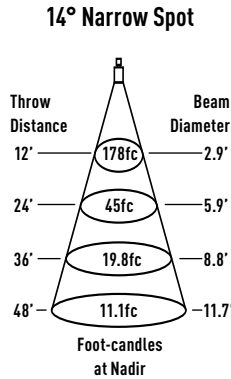

Watts: 17      LPW: 155  
 Lumens: 2636      CCT: 3000K

Intensity	
Degree	CBCP
0°	25682
5°	19415
15°	2170
25°	1039
35°	57
45°	44

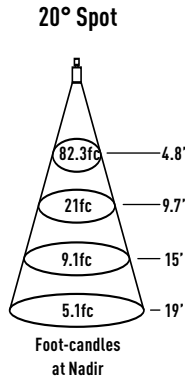

Watts: 17      LPW: 151  
 Lumens: 2563      CCT: 3000K

Intensity	
Degree	CBCP
0°	11852
5°	10084
15°	3533
25°	1078
35°	87
45°	59

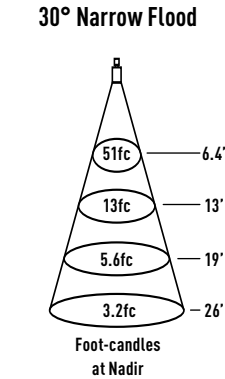

Watts: 17      LPW: 149  
 Lumens: 2535      CCT: 3000K

Intensity	
Degree	CBCP
0°	7266
5°	6807
15°	3605
25°	1521
35°	123
45°	46

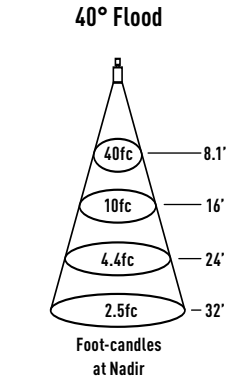

Watts: 17      LPW: 147  
 Lumens: 2503      CCT: 3000K

Intensity	
Degree	CBCP
0°	5738
5°	5499
15°	3672
25°	1624
35°	134
45°	60

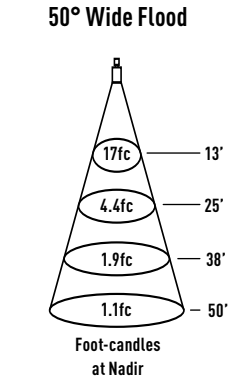

Watts: 17      LPW: 133  
 Lumens: 2255      CCT: 3000K

Intensity	
Degree	CBCP
0°	2507
5°	2453
15°	2076
25°	1457
35°	706
45°	245

JOB NAME		CATALOG NUMBER	
NOTES		TYPE	

## GC6DRL530HZ

Report #: ILL20191216-4.003 (14)  
 ILL20191216-11.003 (20)  
 ILL20191217-7.003 (30)  
 ILL20191217-14.003 (40)  
 ILL20191218-5.003 (50)

### CCT MULTIPLIERS:

	82 CRI	92 CRI
2700K	(x 0.95)	(x 0.79)
3000K	(x 1.00)	(x 0.82)
3500K	(x 1.02)	(x 0.85)
4000K	(x 1.03)	(x 0.88)

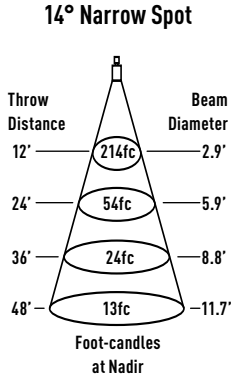

Watts: 22    LPW: 144  
 Lumens: 3165    CCT: 3000K

Intensity	
Degree	CBCP
0°	30837
5°	23311
15°	2606
25°	1247
35°	69
45°	53

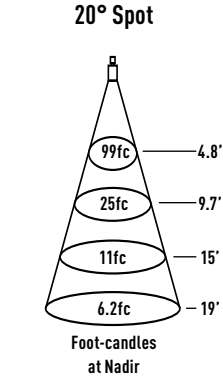

Watts: 22    LPW: 140  
 Lumens: 3077    CCT: 3000K

Intensity	
Degree	CBCP
0°	14231
5°	12107
15°	4242
25°	1294
35°	104
45°	71

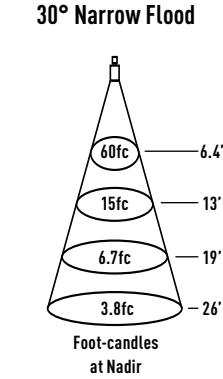

Watts: 23    LPW: 132  
 Lumens: 3044    CCT: 3000K

Intensity	
Degree	CBCP
0°	8725
5°	8173
15°	4329
25°	1827
35°	148
45°	55

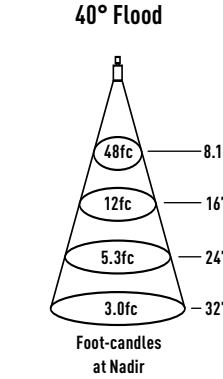

Watts: 22    LPW: 137  
 Lumens: 3005    CCT: 3000K

Intensity	
Degree	CBCP
0°	6889
5°	6602
15°	4409
25°	1950
35°	160
45°	71

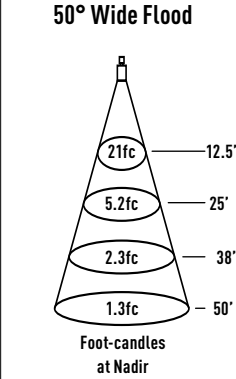

Watts: 22    LPW: 123  
 Lumens: 2708    CCT: 3000K

Intensity	
Degree	CBCP
0°	3011
5°	2945
15°	2493
25°	1749
35°	848
45°	294

## GC6DRL630HZ

Report #: ILL20191216-4.004 (14)  
 ILL20191216-11.004 (20)  
 ILL20191217-7.004 (30)  
 ILL20191217-14.004 (40)  
 ILL20191218-5.004 (50)

### CCT MULTIPLIERS:

	82 CRI	92 CRI
2700K	(x 0.95)	(x 0.79)
3000K	(x 1.00)	(x 0.82)
3500K	(x 1.02)	(x 0.85)
4000K	(x 1.03)	(x 0.88)

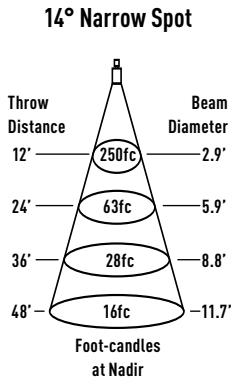

Watts: 28    LPW: 132  
 Lumens: 3694    CCT: 3000K

Intensity	
Degree	CBCP
0°	35991
5°	27208
15°	3041
25°	1455
35°	81
45°	62

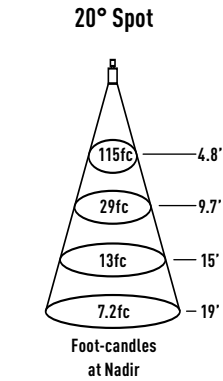

Watts: 28    LPW: 128  
 Lumens: 3592    CCT: 3000K

Intensity	
Degree	CBCP
0°	16610
5°	14131
15°	4951
25°	1510
35°	122
45°	83

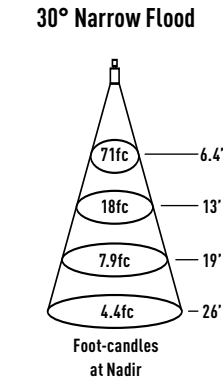

Watts: 28    LPW: 127  
 Lumens: 3553    CCT: 3000K

Intensity	
Degree	CBCP
0°	10183
5°	9539
15°	5053
25°	2132
35°	173
45°	95

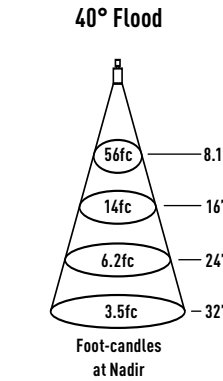

Watts: 28    LPW: 125  
 Lumens: 3507    CCT: 3000K

Intensity	
Degree	CBCP
0°	8040
5°	7706
15°	5146
25°	2276
35°	187
45°	83

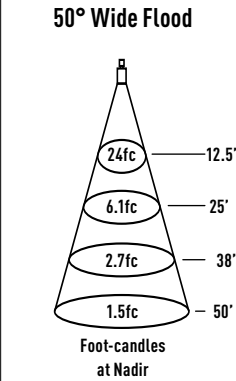

Watts: 28    LPW: 113  
 Lumens: 3160    CCT: 3000K

Intensity	
Degree	CBCP
0°	3514
5°	3437
15°	2910
25°	2041
35°	989
45°	343