

GD2AS

2" Gravity Square LED Lensed Adjustable - Wet Location

JOB NAME		CATALOG NUMBER	
NOTES		TYPE	

ELECTRICAL DATA

LED Light Engine	Nominal Delivered Lumens*	System Wattage**
L1	650lm @ 3000K / 82CRI	10 Watts
L2	950lm @ 3000K / 82CRI	15 Watts
L3	1150lm @ 3000K / 82CRI	20 Watts

* Delivered Lumens will vary depending on CCT, CRI, optic and reflector finish.
 ** System Wattage includes driver and LED Module consumption.

FEATURES

- Field changeable 16° to 60° Optics
- Integral field changeable accessory holder
- Toolless adjustability with 360° of rotation in 90° increments & 45° of tilt
- In-field adjustable module height accommodates 1/2" to 1-1/4" ceiling thickness

LED LIGHT ENGINE

- 10W, 15W & 20W
- 16° to 60° Optics: 2 SDCM, 82/92CRI in 2700K, 3000K, 3500K & 4000K
- Rated life of >50,000 hours L70 based on LED testing per LM-80-08 and projected values using IESNA TM21-11

OPTICS

- Field changeable 16° Spot, 24° Narrow Flood, 36° Flood, 48° Wide Flood and 60° Very Wide Flood
- Accepts (2) field changeable filter media

ELECTRICAL SYSTEM

- 120V/277V input; Power factor >.9, 50/60Hz
- This product complies with IEEE C62.41 for surge endurance up to 2.5KV. Additional surge protection recommended. Damage from power surge is not covered by warranty.

HOUSING

- Heavy duty black powder coated 18 gauge steel frame
- Accommodates 1/2" to 1-1/4" Ceilings
- Integral driver compartment with below ceiling access

EMERGENCY BACKUP

- Remote test switch included. External Battery operates LED load @ 725 nominal delivered Lumens. Servicing requires above ceiling access.
- Available with IC and AIC housings only.

INSTALLATION

- IC and Non-IC Rated housing types, must specify. (Remodel housings are Non-IC only) Non-IC rated housings must be kept at a minimum of 3" away from insulation
- Remodel housings requires 5-1/2" of plenum space for installation and servicing.
- Adjustable (10-3/4" to 25") joist/grid ceiling bar hangers included (Hanger bars does not allow for height adjustments)

REFLECTOR

- Specification grade 1.0mm spun aluminum reflector
- Shallow cone for maximum flexibility and 45° of adjustability
- Reflector available in black, white or haze finishes (Consult factory for other finishes)
- Architectural, discrete polished self flange (**Note:** Not available with trimless trims)

DIMMING

- Phase dimming, Forward 1% & Reversed 5% (120V only)
- 0-10V 1% Dimming 1%
- EldoLED SOLdrive 0-10V 0.1%
- EldoLED ECOdrive 0-10V 1%
- Lutron® LDE1 Hi-Lume 1% EcoSystem LED driver with Soft-on, Fade-to-Black dimming technology

REMOTE BOX

- Remote box included when required by specification (eldoLED or Lutron dimming option). Available with IC and AIC housings only.
- Above ceiling access required for servicing
- Galvanized steel construction with separate line voltage and low voltage wiring compartments
- 50ft remote distance maximum

LISTING / WARRANTY

- 5-Year Intense LED Limited Warranty
- ETL Listed to US and Canadian standards for wet locations
- (-IC / -AIC Only) ETL listed for direct contact w/insulation
- (-AIC Only) Air-Tight Certified ASTM E283.
- (-AIC Only) Can be used to comply with Title 24, Part 6, JA8 high efficacy LED light source requirements



Trimmed Reflectors

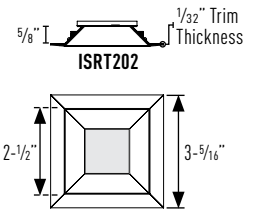
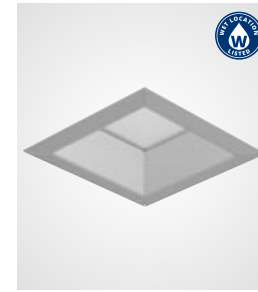

Ceiling Cutout: 2-7/8"

Trimless Reflectors

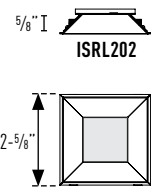
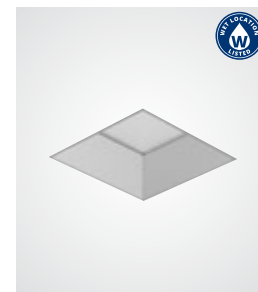

Ceiling Cutout: 2-7/8"

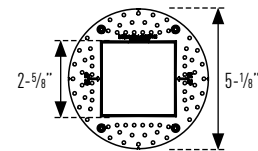

Trimless Mud Flanged:
Perforated collar for seamless and trimless mounting. Must be ordered separately and can only be used in conjunction with trimless trims.

Available Trim Finishes



Housing Part Number: (Example: GD2ASNCL1279DIMSP)

Housing	Installation Type	Wattage	CCT / CRI	Dimming	Voltage	Optic	Options	
GD2AS	NC (New Cons Non-IC)	L1 (10W)	27 (2700K / 82CRI)	DIM ² (Phase Dimming)	blank (120V)	SP (16° SP)	EM7 ^{1,3,4} (7W Emergency Backup IOTA part #ILB-CP07-A)	
	NIC ¹ (New Cons IC-Rated)	L2 (15W)	279 (2700K / 92CRI)	D101 (0-10V Dimming 1%)	27 (277V)	NF (24° NFL)		
	NAIC ¹ (New Cons Air-Tight IC)	L3 (20W)	30 (3000K / 82CRI)	ED10V1 ^{1,3} (eldoLED 0-10V 1%)		FL (36° FL)		
	RC (Remodel Non-IC)		309 (3000K / 92CRI)		ED10V01 ^{1,3} (eldoLED 0-10V 0.1%)			WF (48° WFL)
			35 (3500K / 82CRI)		LUT ^{1,3} (Lutron® LDE1 EcoSystem 1%)			VF (60° VFL)
			359 (3500K / 92CRI)					
			40 (4000K / 82CRI)					
		409 (4000K / 92CRI)						

Reflector Part Number: (Example: ISRT202W-SF)

Reflector	Reflector Finish	Trim	Lens
ISRT202 (5/8" Regress Trim)	W (White)	-SF (Self Flanged)	-SL (Solite)
ISRL202 ⁵ (5/8" Regress Trimless)	B ⁴ (Black)	blank ⁵ (Trimless)	
	HZ (Haze)		

Optional Accessory

GD2S-MR⁵ Square Trimless Mud Ring

Filter Media

PFL2-45 Hex Louver
 PFL4-45 Soft Focus Film
 PFL-LS-45 Linear Spread

Notes:

- Not available with L3
- Available in 120V only
- Remote driver box required for eldoLED, Lutron and EM back up. Compatible with IC and AIC rated housings only.
- Emergency backup available with IC and AIC housings only
- Trimless options are for use with mud ring accessory only
- Consult factory for lead times

GRAVITY L/M-0906.23 P-10

Intense Lighting

3340 E La Palma Ave, Anaheim, CA 92806 | tel 714 630-9877 | fax 714 630-9883

©2023 Intense Lighting, LLC. All rights reserved. Subject to change without notice.

GD2AS

2" Gravity Square LED Lensed Adjustable - Wet Location

JOB NAME		CATALOG NUMBER	
NOTES		TYPE	

New Construction Dimension (IC & Non-IC):

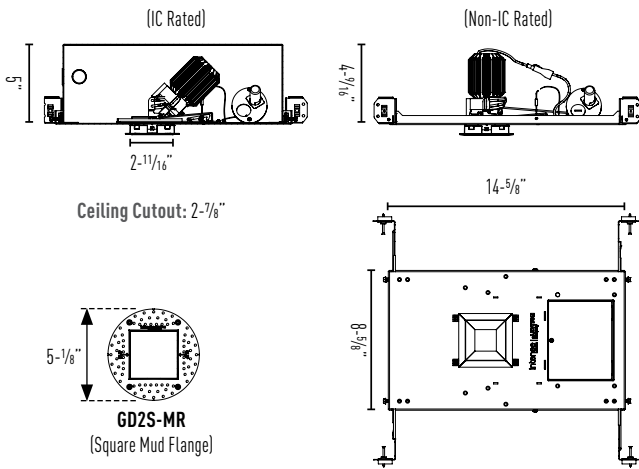

Remodel Dimension (Non-IC):

Remodel housings requires 5-1/2" of plenum space for installation and servicing.

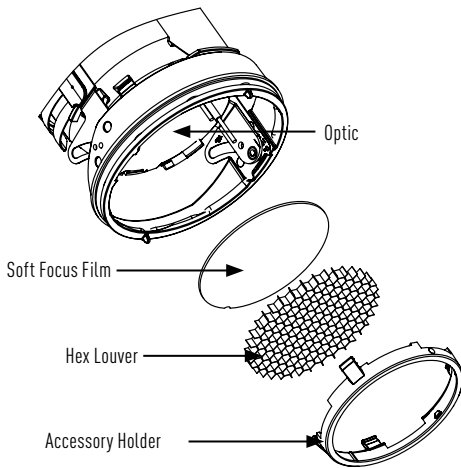
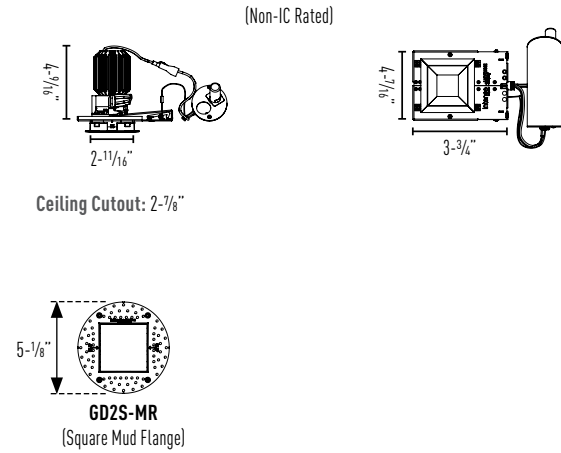

Optics

Field changeable 16° to 60° Optics

- IP-OP45SP** (16° Spot)
- IP-OP45NF** (24° Narrow Flood)
- IP-OP45FL** (36° Flood)
- IP-OP45WF** (48° Wide Flood)
- IP-OP45VF** (60° Very Wide Flood)

Accessories

- PFL2-45** Hex Louver
- PFL4-45** Soft Focus Film
- PFL-LS-45** Linear Spread

Remote Mounted Driver

(For use with IC/AIC housings with eldoLED or Lutron dimming option)

- Remote box included when required by specification (eldoLED or Lutron dimming option). Available with IC and AIC housings only.
- Above ceiling access required for servicing
- Galvanized steel construction with separate line voltage and low voltage wiring compartments
- 50ft remote distance maximum

Remote Driver Box For Dimming Options

- eldoLED 0-10V 1%
- eldoLED 0-10V 0.1%
- Lutron® LDE1 EcoSystem 1%
- Lutron® LTEA2W 2-Wire 1%

Note: Wires for class 2 LED driver require a minimum of 18 awg wire at a maximum of 50 feet length per local and national electrical regulations.

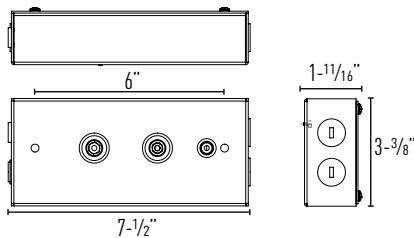

GD2AS

2" Gravity Square LED Lensed Adjustable - Wet Location

JOB NAME		CATALOG NUMBER	
NOTES		TYPE	

ISRT202WL3

Report #: ILL-20190114-1 (16)
 ILL-20190114-1 (24)
 ILL-20190114-1 (36)
 ILL-20190114-1 (48)
 ILL-20190114-1 (60)

LED PACKAGE MULTIPLIERS:
 ISRT202WL1 (x 0.58)
 ISRT202WL2 (x 0.82)

ISRT200 (%/" REGRESS)
 Trim Multiplier (x 0.99)

CCT MULTIPLIERS:

	82CRI	92CRI
2700K	(x 0.93)	(x 0.76)
3000K	(x 1.00)	(x 0.87)
3500K	(x 1.00)	(x 0.87)
4000K	(x 1.00)	(x 0.87)

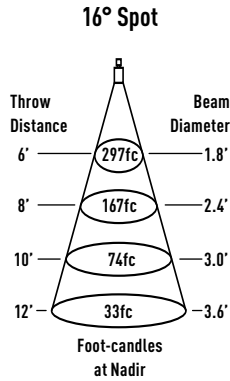

Watts: 20 LPW: 63
 Lumens: 1260 CCT: 3000K

Intensity	
Degree	CBCP
0°	15914
5°	13019
15°	1498
25°	276
35°	44
45°	13

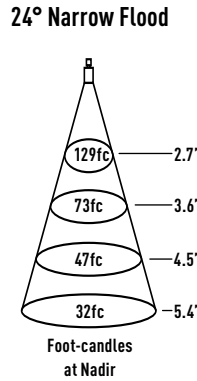

Watts: 20 LPW: 58
 Lumens: 1176 CCT: 3000K

Intensity	
Degree	CBCP
0°	4651
5°	4128
15°	1781
25°	437
35°	95
45°	25

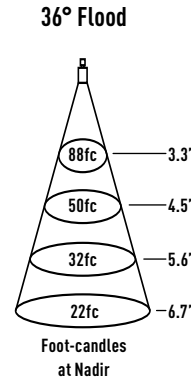

Watts: 20 LPW: 57
 Lumens: 1142 CCT: 3000K

Intensity	
Degree	CBCP
0°	3179
5°	2951
15°	1644
25°	550
35°	154
45°	40

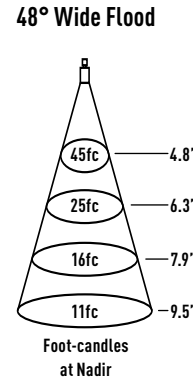

Watts: 20 LPW: 51
 Lumens: 1033 CCT: 3000K

Intensity	
Degree	CBCP
0°	1615
5°	1554
15°	1153
25°	616
35°	267
45°	89

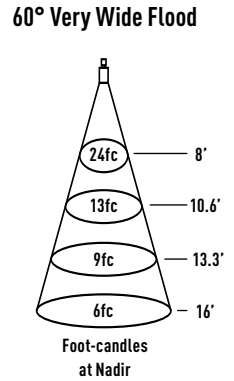

Watts: 20 LPW: 48
 Lumens: 965 CCT: 3000K

Intensity	
Degree	CBCP
0°	1435
5°	1393
15°	1242
25°	921
35°	504
45°	170

APPLICATION DATA:

W and L are the outer points where the candle power drops to 50% of maximum. FC are the initial foot candles at the center of the beam.

W: Beam width
 L: Beam length
 C: Distance to center of beam
 D: Distance
 FC: Foot-candles

Illuminated width & length are based upon point at which illuminance falls to 50% of center illuminance. Recommended spacing is based upon uniform illuminance aiming angle is the angle between the lamp axis and the perpendicular to the illuminated plane.

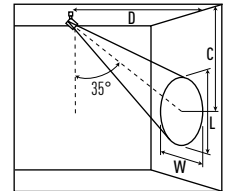
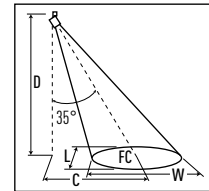
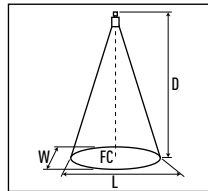

	0° HORIZONTAL				35° HORIZONTAL				35° VERTICAL					
	D	FC	W	L	D	C	FC	W	L	D	C	FC	W	L
ISRT202WL2WL3 3000K 16° Spot	6'	297	1.8	1.8	6'	4.2	163	2.7	2.2	3'	4.3	224	1.6	2.8
	8'	167	2.4	2.4	8'	5.6	92	3.6	2.9	4'	5.7	126	2.1	3.8
	10'	74	3	3	10'	7	59	4.5	3.7	5'	7.1	81	2.6	4.8
	12'	33	3.6	3.6	12'	8.4	41	5.4	4.4	6'	8.6	56	3.1	5.7
ISRT202WL2WL3 3000K 24° Narrow Flood	6'	129	2.7	2.7	6'	4.2	71	4.1	3.3	3'	4.3	98	2.4	4.6
	8'	73	3.6	3.6	8'	5.6	40	5.5	4.4	4'	5.7	55	3.2	6.1
	10'	47	4.5	4.5	10'	7	26	6.8	5.5	5'	7.1	35	3.9	7.6
	12'	32	5.4	5.4	12'	8.4	18	8.2	6.6	6'	8.6	24	4.7	9.1
ISRT202WL2WL3 3000K 36° Flood	6'	88	3.3	3.3	6'	4.2	49	5.1	4.1	3'	4.3	67	2.9	5.9
	8'	50	4.5	4.5	8'	5.6	27	6.8	5.4	4'	5.7	38	3.9	7.9
	10'	32	5.6	5.6	10'	7	18	8.5	6.8	5'	7.1	24	4.9	9.9
	12'	22	6.7	6.7	12'	8.4	12	10.2	8.2	6'	8.6	17	5.8	11.9
ISRT202WL2WL3 3000K 48° Wide Flood	6'	45	4.8	4.8	6'	4.2	25	7.5	5.8	3'	4.3	34	4.1	10.2
	8'	25	6.3	6.3	8'	5.6	14	10	7.7	4'	5.7	19	5.5	13.7
	10'	16	7.9	7.9	10'	7	9	12.5	9.7	5'	7.1	12	6.9	17.1
	12'	11	9.5	9.5	12'	8.4	6	15	11.6	6'	8.6	8	8.3	20.5
ISRT202WL2WL3 3000K 60° Very Wide Flood	6'	24	8	8	6'	4.2	13	15.2	9.7	3'	4.3	18	7	12.9
	8'	13	10.6	10.6	8'	5.6	7	20.3	13	4'	5.7	10	9.2	17.3
	10'	9	13.3	13.3	10'	7	5	25.4	16.2	5'	7.1	6	11.6	21.6
	12'	6	16	16	12'	8.4	3	30.5	19.5	6'	8.6	4	13.9	25.9

GRAVITY L/M-0906-23 P-12

Intense Lighting

3340 E La Palma Ave, Anaheim, CA 92806 | tel 714 630-9877 | fax 714 630-9883

©2023 Intense Lighting, LLC. All rights reserved. Subject to change without notice.

