

GD6AR / IRA600

6" Gravity LED Adjustable

JOB NAME		CATALOG NUMBER	
NOTES		TYPE	

ELECTRICAL DATA: (Data Based On 3000K/82CRI Configuration)

LED Light Engine	Nominal Delivered Lumens *	System Wattage **	Efficacy	LED Light Engine	Nominal Delivered Lumens *	System Wattage **	Efficacy
L1	1000lm	10W	100 lm/W	L7	4000lm	36W	111 lm/W
L2	1500lm	12W	125 lm/W	L8	4500lm	43W	105 lm/W
L3	2000lm	14W	143 lm/W	L9	5000lm	49W	102 lm/W
L4	2500lm	18 W	139 lm/W	L10	6000lm	50W	120 lm/W
L5	3000lm	23W	130 lm/W	L11	7000lm	60W	117 lm/W
L6	3500lm	30W	117 lm/W				

* Delivered lumen output will vary depending on CCT, CRI, optic and reflector finish. | ** System Wattage include driver and LED Module consumption.

LED LIGHT ENGINE

- 82/92 CRI, 2700K, 3000K, 3500K or 4000K
- 2 Step MacAdam (2 SDCM)
- Rated life of >50,000 hours L70 based on LED testing per LM-80-08 and projected values using IESNA TM21-11

DIMMING

- Forward/Reverse Phase Dimming 5% (120V only)
- 0-10V Dimming 1%
- eldoLED 0-10V 0.1% or 1%
- Lutron® LDE1 Hi-Lume 1% EcoSystem LED driver with Soft-on, Fade-to-Black dimming technology
- DMX512 RDM 0.1%

OPTICS

- 14° Narrow Spot, 20° Spot, 30° Narrow Flood, 40° Flood, 50° Wide Flood and 60° Very Wide Flood
- Optics and filter media are field interchangeable

ELECTRICAL SYSTEM

- Dedicated voltage options of 120V, 277V or 347V. Must be specified in catalog code
- 347V available with -D101 in L1 to L7 only, consult factory for lead times
- Multiple dimming drivers available
- This product complies with IEEE C62.41 for surge endurance up to 2.5KV. Additional surge protection recommended. Damage from power surge is not covered by warranty.

FRAME CONSTRUCTION

Constructed from 16 and 18 gauge heavy duty powder coated cold rolled steel frame with a large access junction box. ETL listed for through wiring. LED light engine and driver are accessible from above or below ceiling. 40° vertical and 362° horizontal adjustment with locking.

REFLECTOR

Specification grade reflector with 1.5mm thickness. Reflector available in black, clear, haze or white finish. Consult factory for other colors. Architectural, discrete polished self flange standard. Optional painted white flange is available.

INSTALLATION

The luminaire is type Non-IC. Insulation must be kept at a minimum of 3" away from fixture. Accommodates up to 1 1/4" ceiling thickness. Universal mounting brackets included. Compatible with C-channel, flat bar, wood joist bar hanger and EMT. Bar hangers must be ordered separately. C-channel is recommended for T-bar ceilings. Max. ambient temperature: 95°F (35°C).

EMERGENCY BACKUP

Remote test switch included. External battery operates LED load of up to 7W at a minimum of 400 lumens for 90 minutes (EM7), or 20W at a minimum of 1200 lumens for 90 minutes (EM20).

ACCESSORIES

Luminaire accepts (1) media filter and (1) hex cell louver.

LISTING / WARRANTY

- ETL Listed to US and Canadian standards for damp locations
- 5-Year Intense LED Limited Warranty

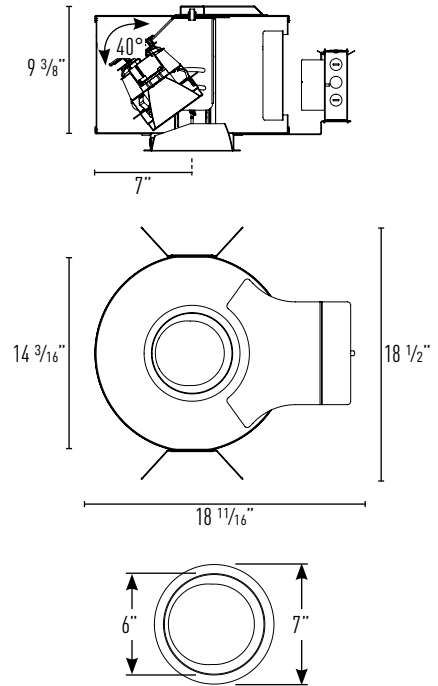

Ceiling Cut Out: 6 1/2"
Maximum Ceiling Thickness: 1 1/4"

Housing Part Number: (Example: GD6ARL327-DIM-NS)

Housing	Wattage		CCT / CRI	Dimming		Voltage	Optic	Options							
GD6AR	L1 ¹	(10W)	L7	(36W)	27	(2700K/82CRI)	-DIM ²	(Phase Dimming 5%)	blank	(120V)	-NS ⁴	(14° Narrow Spot)	EM7	(7W Emergency Backup w/ Remote Test Switch	
	L2 ¹	(12W)	L8	(43W)	279	(2700K/92 CRI)	-D101	(0-10V Dimming 1%)	27	(277V)	-SP	(20° Spot)			
	L3	(14W)	L9	(49W)	30	(3000K/82 CRI)	-ED10V1 ³	(eldoLED 0-10V 1%)	34 ⁹	(347V)	-NF	(30° Narrow Flood)			
	L4	(18W)	L10	(50W)	309	(3000K/92 CRI)	-ED10V01 ³	(eldoLED 0-10V 0.1%)			-FL	(40° Flood)	EM20 ¹⁰	(20W Emergency Backup w/ Remote Test Switch	
	L5	(23W)	L11	(60W)	35	(3500K/82 CRI)	-LUT ⁴	(Lutron® LDE1 EcoSystem 1%)			-WF ⁷	(50° Wide Flood)			
	L6	(30W)			359	(3500K/92 CRI)	-DMXR ⁵	(DMX512 RDM 0.1%)			-VF ⁸	(60° Very Wide Flood)			
					40	(4000K/82 CRI)									
					409	(4000K/92 CRI)									

Reflector Part Number: (Example: IRA600HZ-SF)

Reflector	Reflector Finish	
IRA600	HZ-SF	(Haze, Self-Flanged)
	HZ-SFW	(Haze, Self-Flanged White)
	W-SF	(White, Self-Flanged)
	C-SF	(Clear, Self-Flanged)
	C-SFW	(Clear, Self-Flanged White)
	B-SF ¹¹	(Black, Self-Flanged)

Accessories

PFL2-111	(Linear Spread)
PFL4-111	(Soft Focus Lens)
PFLMB-111	(Black Hex Louver)
I100	(C-Channel Bar Hangers)
I200	(Flat Bar Hangers)
I400	(Wood Joist Bar Hangers)

Notes:

- L1 & L2 only available with -D101
- Available in 120V only and Not available with L14
- eldoLED dimming available with L3-L11
- Lutron® dimming available with L3-L8
- DMX512 RDM available with L4-L11
- 14° Optic (NS) available on L1-L9 only
- 50° for L1-L9 only accepts (1) media filter
- 60° Optic (VF) available on L10-L11 only. Accepts only one filter media accessory.
- 347V available with -D101 in L1 to L7 only, consult factory for lead times.
- EM20 only available for L5 to L11
- Consult Factory For Lead Times

GRAVITY ADJUSTABLE L/M-049-24-P-1

INTENSE LIGHTING | 3340 E La Palma Ave, Anaheim, CA 92806 | tel 714 630-9877 | fax 714 630-9883

For Intense Lighting's limited product warranty, go to www.intenselighting.com. For a printed copy of the warranty, you may call 800 961-5321.

© 2024 Intense Lighting, LLC. All rights reserved. Note: This document is subject to change without notice.



JOB NAME		CATALOG NUMBER	
NOTES		TYPE	

GD6ARL3 IRA600HZ

Report #: ILL20191216-4.001 (14)
 ILL20191216-11.001 (20)
 ILL20191217-7.001 (30)
 ILL20191217-14.001 (40)
 ILL20191218-5.001 (50)

CCT MULTIPLIERS:

	82 CRI	92 CRI
2700K	(x 0.95)	(x 0.79)
3000K	(x 1.00)	(x 0.82)
3500K	(x 1.02)	(x 0.85)
4000K	(x 1.03)	(x 0.88)

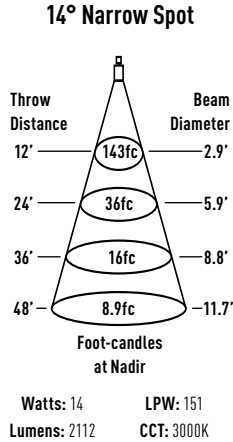

Intensity	
Degree	CBCP
0°	20572
5°	15552
15°	1738
25°	832
35°	46
45°	35

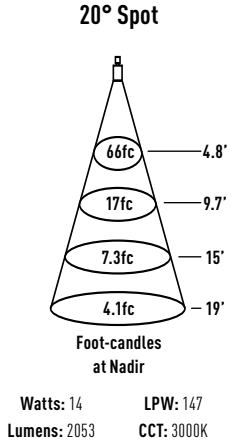

Intensity	
Degree	CBCP
0°	9494
5°	8077
15°	2830
25°	863
35°	70
45°	47

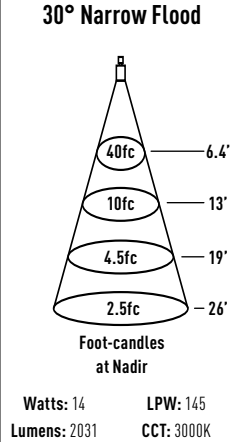

Intensity	
Degree	CBCP
0°	5821
5°	5453
15°	2888
25°	1219
35°	99
45°	37

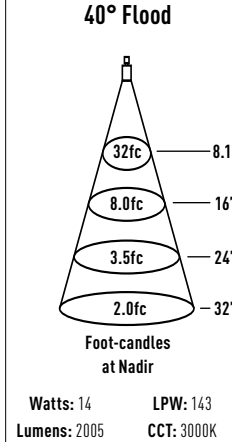

Intensity	
Degree	CBCP
0°	4596
5°	4405
15°	2942
25°	1301
35°	107
45°	48

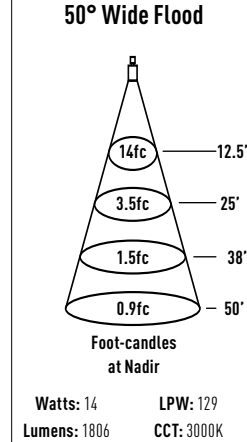

Intensity	
Degree	CBCP
0°	2008
5°	1965
15°	1663
25°	1167
35°	565
45°	196

APPLICATION DATA:

W and L are the outer points where the candle power drops to 50% of maximum. FC are the initial foot candles at the center of the beam.

- W Beam width
- L Beam length
- C Distance to center of beam
- D Distance
- FC Footcandles

Illuminated width & length are based upon point at which illuminance falls to 50% of center illuminance. Recommended spacing is based upon uniform illuminance aiming angle is the angle between the lamp axis and the perpendicular to the illuminated plane.

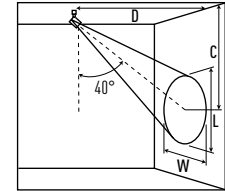
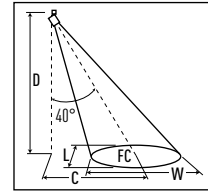
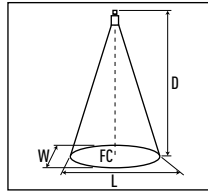

	D	FC	W	L	D	C	FC	W	L	D	C	FC	W	L
GD6ARL330-14 14° Narrow Spot	12'	142.86	2.93	2.93	12'	10.07	64.22	5.05	3.83	6'	7.15	151.77	2.28	3.63
	24'	35.72	5.87	5.87	24'	20.14	16.06	10.10	7.66	12'	14.3	37.94	4.56	7.25
	36'	15.87	8.8	8.8	36'	30.21	7.14	15.15	11.49	18'	21.45	16.86	6.84	10.88
	48'	8.93	11.73	11.73	48'	40.28	4.01	20.21	15.32	24'	28.6	9.49	9.13	14.51
GD6ARL330-20 20° Spot	12'	65.93	4.83	4.83	12'	10.07	29.64	8.48	6.31	6'	7.15	70.04	3.76	6.21
	24'	16.48	9.67	9.67	24'	20.14	7.41	16.96	12.62	12'	14.3	17.51	7.52	12.42
	36'	7.33	14.5	14.5	36'	30.21	3.29	25.44	18.93	18'	21.45	7.78	11.28	18.63
	48'	4.12	19.34	19.34	48'	40.28	1.85	33.93	25.25	24'	28.6	4.38	15.04	24.84
GD6ARL330-30 30° Narrow Flood	12'	40.42	6.39	6.39	12'	10.07	18.17	11.46	8.34	6'	7.15	42.94	4.97	8.6
	24'	10.11	12.78	12.78	24'	20.14	4.54	22.93	16.69	12'	14.3	10.73	9.94	17.2
	36'	4.49	19.17	19.17	36'	30.21	2.02	34.39	25.03	18'	21.45	4.77	14.91	25.8
	48'	2.53	25.57	25.57	48'	40.28	1.14	45.85	33.37	24'	28.6	2.68	19.89	34.4
GD6ARL330-40 40° Flood	12'	31.92	8.09	8.09	12'	10.07	14.35	14.98	10.56	6'	7.15	33.91	6.29	11.67
	24'	7.98	16.18	16.18	24'	20.14	3.59	29.96	21.12	12'	14.3	8.48	12.58	23.34
	36'	3.55	24.27	24.27	36'	30.21	1.59	44.95	31.68	18'	21.45	3.77	18.88	35.01
	48'	1.99	32.35	32.35	48'	40.28	0.90	59.93	42.24	24'	28.6	2.12	25.17	46.68
GD6ARL330-50 50° Wide Flood	12'	13.95	12.55	12.55	12'	10.07	6.27	26.47	16.38	6'	7.15	14.82	9.76	24.82
	24'	3.49	25.09	25.09	24'	20.14	1.57	52.95	32.76	12'	14.30	3.7	19.52	49.63
	36'	1.55	37.64	37.64	36'	30.21	0.70	79.42	49.14	18'	21.45	1.65	29.28	74.45
	48'	0.87	50.19	50.19	48'	40.28	0.39	105.9	65.51	24'	28.6	0.93	39.04	99.26

JOB NAME		CATALOG NUMBER	
NOTES		TYPE	

GD6ARL4 IRA600HZ

Report #: ILL20191216-4.002 (14)
 ILL20191216-11.002 (20)
 ILL20191217-7.002 (30)
 ILL20191217-14.002 (40)
 ILL20191218-5.002 (50)

CCT MULTIPLIERS:

	82 CRI	92 CRI
2700K	(x 0.95)	(x 0.79)
3000K	(x 1.00)	(x 0.82)
3500K	(x 1.02)	(x 0.85)
4000K	(x 1.03)	(x 0.88)

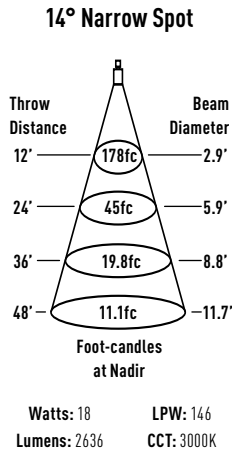

Intensity	
Degree	CBCP
0°	25682
5°	19415
15°	2170
25°	1039
35°	57
45°	44

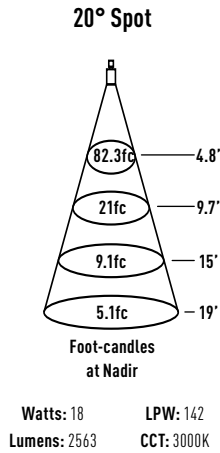

Intensity	
Degree	CBCP
0°	11852
5°	10084
15°	3533
25°	1078
35°	87
45°	59

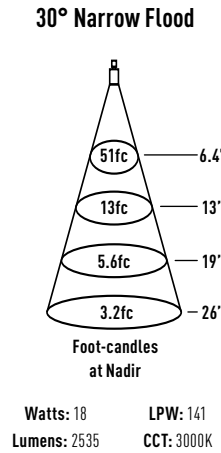

Intensity	
Degree	CBCP
0°	7266
5°	6807
15°	3605
25°	1521
35°	123
45°	46

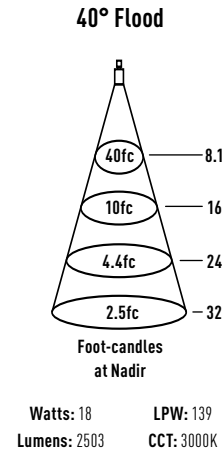

Intensity	
Degree	CBCP
0°	5738
5°	5499
15°	3672
25°	1624
35°	134
45°	60

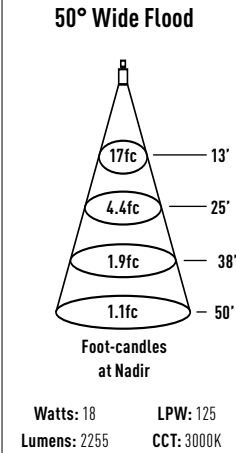

Intensity	
Degree	CBCP
0°	2507
5°	2453
15°	2076
25°	1457
35°	706
45°	245

APPLICATION DATA:

W and L are the outer points where the candle power drops to 50% of maximum. FC are the initial foot candles at the center of the beam.

- W Beam width
- L Beam length
- C Distance to center of beam
- D Distance
- FC Footcandles

Illuminated width & length are based upon point at which illuminance falls to 50% of center illuminance. Recommended spacing is based upon uniform illuminance aiming angle is the angle between the lamp axis and the perpendicular to the illuminated plane.

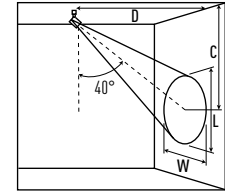
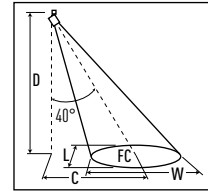
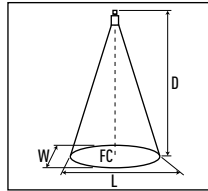

	D	FC	W	L	D	C	FC	W	L	D	C	FC	W	L
GD6ARL430-14 14° Narrow Spot	12'	178.35	2.93	2.93	12'	10.07	80.17	5.05	3.83	6'	7.15	189.47	2.28	3.63
	24'	44.59	5.87	5.87	24'	20.14	20.04	10.10	7.66	12'	14.3	47.37	4.56	7.25
	36'	19.82	8.8	8.8	36'	30.21	8.91	15.15	11.49	18'	21.45	21.05	6.84	10.88
	48'	11.15	11.73	11.73	48'	40.28	5.01	20.21	15.32	24'	28.6	11.84	9.13	14.51
GD6ARL430-20 20° Spot	12'	82.31	4.83	4.83	12'	10.07	37.00	8.48	6.31	6'	7.15	87.44	3.76	6.21
	24'	20.58	9.67	9.67	24'	20.14	9.25	16.96	12.62	12'	14.3	21.86	7.52	12.42
	36'	9.15	14.5	14.5	36'	30.21	4.11	25.44	18.93	18'	21.45	9.72	11.28	18.63
	48'	5.14	19.34	19.34	48'	40.28	2.31	33.93	25.25	24'	28.6	5.46	15.04	24.84
GD6ARL430-30 30° Narrow Flood	12'	50.46	6.39	6.39	12'	10.07	22.68	11.46	8.34	6'	7.15	53.61	4.97	8.6
	24'	12.62	12.78	12.78	24'	20.14	5.67	22.93	16.69	12'	14.3	13.40	9.94	17.2
	36'	5.61	19.17	19.17	36'	30.21	2.52	34.39	25.03	18'	21.45	5.96	14.91	25.8
	48'	3.15	25.57	25.57	48'	40.28	1.42	45.85	33.37	24'	28.6	3.35	19.89	34.4
GD6ARL430-40 40° Flood	12'	39.84	8.09	8.09	12'	10.07	17.91	14.98	10.56	6'	7.15	42.33	6.29	11.67
	24'	9.96	16.18	16.18	24'	20.14	4.48	29.96	21.12	12'	14.3	10.58	12.58	23.34
	36'	4.43	24.27	24.27	36'	30.21	1.99	44.95	31.68	18'	21.45	4.70	18.88	35.01
	48'	2.49	32.35	32.35	48'	40.28	1.12	59.93	42.24	24'	28.6	2.65	25.17	46.68
GD6ARL430-50 50° Wide Flood	12'	39.84	12.55	12.55	12'	10.07	7.83	26.47	16.38	6'	7.15	18.50	9.76	24.82
	24'	9.96	25.09	25.09	24'	20.14	1.96	52.95	32.76	12'	14.30	4.62	19.52	49.63
	36'	4.43	37.64	37.64	36'	30.21	0.87	79.42	49.14	18'	21.45	2.06	29.28	74.45
	48'	2.49	50.19	50.19	48'	40.28	0.49	105.9	65.51	24'	28.6	1.16	39.04	99.26

JOB NAME		CATALOG NUMBER	
NOTES		TYPE	

GD6ARL5 IRA600HZ

Report #: ILL20191216-4.003 (14)
 ILL20191216-11.003 (20)
 ILL20191217-7.003 (30)
 ILL20191217-14.003 (40)
 ILL20191218-5.003 (50)

CCT MULTIPLIERS:
82 CRI **92 CRI**
 2700K (x 0.95) (x 0.79)
 3000K (x 1.00) (x 0.82)
 3500K (x 1.02) (x 0.85)
 4000K (x 1.03) (x 0.88)

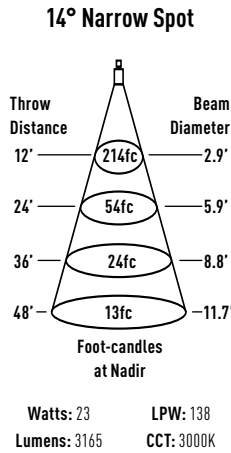

Intensity	
Degree	CBCP
0°	30837
5°	23311
15°	2606
25°	1247
35°	69
45°	53

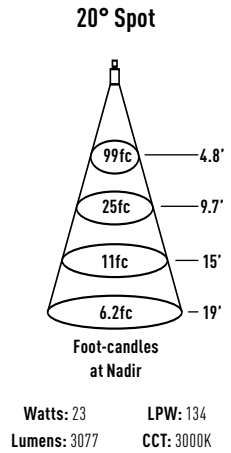

Intensity	
Degree	CBCP
0°	14231
5°	12107
15°	4242
25°	1294
35°	104
45°	71

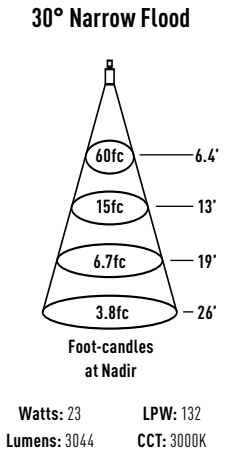

Intensity	
Degree	CBCP
0°	8725
5°	8173
15°	4329
25°	1827
35°	148
45°	55

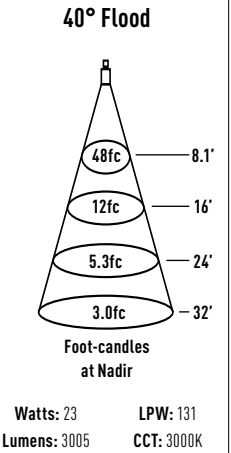

Intensity	
Degree	CBCP
0°	6889
5°	6602
15°	4409
25°	1950
35°	160
45°	71

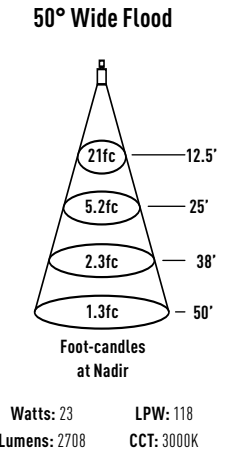

Intensity	
Degree	CBCP
0°	3011
5°	2945
15°	2493
25°	1749
35°	848
45°	294

APPLICATION DATA:

W and **L** are the outer points where the candle power drops to 50% of maximum. **FC** are the initial foot candles at the center of the beam.

W Beam width
L Beam length
C Distance to center of beam
D Distance
FC Footcandles

Illuminated width & length are based upon point at which illuminance falls to 50% of center illuminance. Recommended spacing is based upon uniform illuminance aiming angle is the angle between the lamp axis and the perpendicular to the illuminated plane.

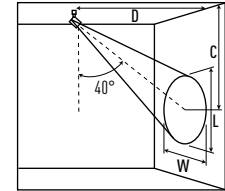
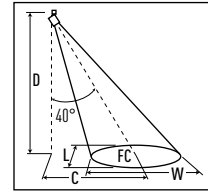
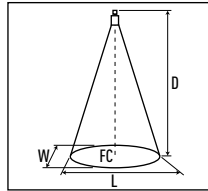

	D	FC	W	L	D	C	FC	W	L	D	C	FC	W	L
GD6ARL530-14 14° Narrow Spot	12'	214.14	2.93	2.93	12'	10.07	96.26	5.05	3.83	6'	7.15	227.49	2.28	3.63
	24'	53.54	5.87	5.87	24'	20.14	24.07	10.10	7.66	12'	14.3	56.87	4.56	7.25
	36'	23.79	8.8	8.8	36'	30.21	10.70	15.15	11.49	18'	21.45	25.28	6.84	10.88
	48'	13.38	11.73	11.73	48'	40.28	6.02	20.21	15.32	24'	28.6	14.22	9.13	14.51
GD6ARL530-20 20° Spot	12'	98.83	4.83	4.83	12'	10.07	44.43	8.48	6.31	6'	7.15	104.99	3.76	6.21
	24'	24.71	9.67	9.67	24'	20.14	11.11	16.96	12.62	12'	14.3	26.25	7.52	12.42
	36'	10.98	14.5	14.5	36'	30.21	4.94	25.44	18.93	18'	21.45	11.67	11.28	18.63
	48'	6.18	19.34	19.34	48'	40.28	2.78	33.93	25.25	24'	28.6	6.56	15.04	24.84
GD6ARL530-30 30° Narrow Flood	12'	60.59	6.39	6.39	12'	10.07	27.24	11.46	8.34	6'	7.15	64.36	4.97	8.6
	24'	15.15	12.78	12.78	24'	20.14	6.81	22.93	16.69	12'	14.3	16.09	9.94	17.2
	36'	6.73	19.17	19.17	36'	30.21	3.03	34.39	25.03	18'	21.45	7.15	14.91	25.8
	48'	3.79	25.57	25.57	48'	40.28	1.70	45.85	33.37	24'	28.6	4.02	19.89	34.4
GD6ARL530-40 40° Flood	12'	47.84	8.09	8.09	12'	10.07	21.51	14.98	10.56	6'	7.15	50.82	6.29	11.67
	24'	11.96	16.18	16.18	24'	20.14	5.38	29.96	21.12	12'	14.3	12.71	12.58	23.34
	36'	5.32	24.27	24.27	36'	30.21	2.39	44.95	31.68	18'	21.45	5.65	18.88	35.01
	48'	2.99	32.35	32.35	48'	40.28	1.34	59.93	42.24	24'	28.6	3.18	25.17	46.68
GD6ARL530-50 50° Wide Flood	12'	20.91	12.55	12.55	12'	10.07	9.40	26.47	16.38	6'	7.15	22.21	9.76	24.82
	24'	5.23	25.09	25.09	24'	20.14	2.35	52.95	32.76	12'	14.30	5.55	19.52	49.63
	36'	2.32	37.64	37.64	36'	30.21	1.04	79.42	49.14	18'	21.45	2.47	29.28	74.45
	48'	1.31	50.19	50.19	48'	40.28	0.59	105.9	65.51	24'	28.6	1.39	39.04	99.26

JOB NAME		CATALOG NUMBER	
NOTES		TYPE	

GD6ARL6 IRA600HZ

Report #: ILL20191216-4.004 (14)
 ILL20191216-11.004 (20)
 ILL20191217-7.004 (30)
 ILL20191217-14.004 (40)
 ILL20191218-5.004 (50)

CCT MULTIPLIERS:

	82 CRI	92 CRI
2700K	(x 0.95)	(x 0.79)
3000K	(x 1.00)	(x 0.82)
3500K	(x 1.02)	(x 0.85)
4000K	(x 1.03)	(x 0.88)

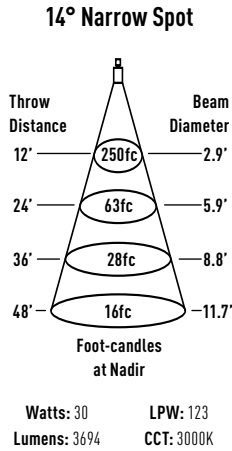

Intensity	
Degree	CBCP
0°	35991
5°	27208
15°	3041
25°	1455
35°	81
45°	62

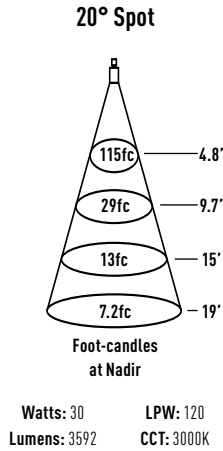

Intensity	
Degree	CBCP
0°	16610
5°	14131
15°	4951
25°	1510
35°	122
45°	83

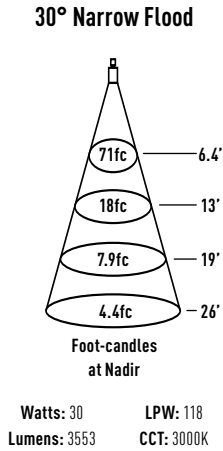

Intensity	
Degree	CBCP
0°	10183
5°	9539
15°	5053
25°	2132
35°	173
45°	95

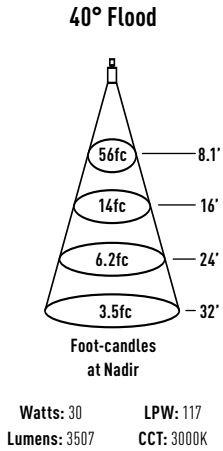

Intensity	
Degree	CBCP
0°	8040
5°	7706
15°	5146
25°	2276
35°	187
45°	83

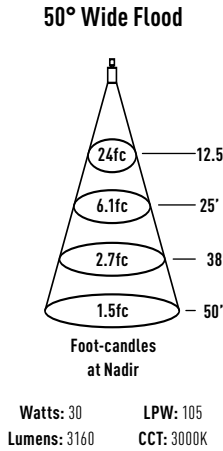

Intensity	
Degree	CBCP
0°	3514
5°	3437
15°	2910
25°	2041
35°	989
45°	343

APPLICATION DATA:

W and L are the outer points where the candle power drops to 50% of maximum. FC are the initial foot candles at the center of the beam.

- W Beam width
- L Beam length
- C Distance to center of beam
- D Distance
- FC Footcandles

Illuminated width & length are based upon point at which illuminance falls to 50% of center illuminance. Recommended spacing is based upon uniform illuminance aiming angle is the angle between the lamp axis and the perpendicular to the illuminated plane.

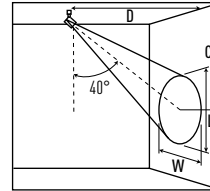
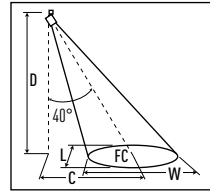
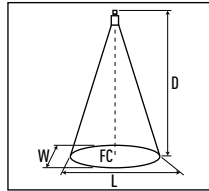

	D	FC	W	L	D	C	FC	W	L	D	C	FC	W	L
GD6ARL630-14 14° Narrow Spot	12'	249.94	2.93	2.93	12'	10.07	112.35	5.05	3.83	6'	7.15	265.52	2.28	3.63
	24'	62.48	5.87	5.87	24'	20.14	28.09	10.10	7.66	12'	14.3	66.38	4.56	7.25
	36'	27.77	8.8	8.8	36'	30.21	12.48	15.15	11.49	18'	21.45	29.50	6.84	10.88
	48'	15.62	11.73	11.73	48'	40.28	7.02	20.21	15.32	24'	28.6	16.59	9.13	14.51
GD6ARL630-20 20° Spot	12'	115.34	4.83	4.83	12'	10.07	51.85	8.48	6.31	6'	7.15	122.54	3.76	6.21
	24'	28.84	9.67	9.67	24'	20.14	12.96	16.96	12.62	12'	14.3	30.63	7.52	12.42
	36'	12.82	14.5	14.5	36'	30.21	5.76	25.44	18.93	18'	21.45	13.62	11.28	18.63
	48'	7.21	19.34	19.34	48'	40.28	3.24	33.93	25.25	24'	28.6	7.66	15.04	24.84
GD6ARL630-30 30° Narrow Flood	12'	70.71	6.39	6.39	12'	10.07	31.79	11.46	8.34	6'	7.15	75.12	4.97	8.6
	24'	17.68	12.78	12.78	24'	20.14	7.95	22.93	16.69	12'	14.3	18.78	9.94	17.2
	36'	7.86	19.17	19.17	36'	30.21	3.53	34.39	25.03	18'	21.45	8.35	14.91	25.8
	48'	4.42	25.57	25.57	48'	40.28	1.99	45.85	33.37	24'	28.6	4.70	19.89	34.4
GD6ARL630-40 40° Flood	12'	55.84	8.09	8.09	12'	10.07	25.10	14.98	10.56	6'	7.15	59.32	6.29	11.67
	24'	13.96	16.18	16.18	24'	20.14	6.28	29.96	21.12	12'	14.3	14.83	12.58	23.34
	36'	6.20	24.27	24.27	36'	30.21	2.79	44.95	31.68	18'	21.45	6.59	18.88	35.01
	48'	3.49	32.35	32.35	48'	40.28	1.57	59.93	42.24	24'	28.6	3.71	25.17	46.68
GD6ARL630-50 50° Wide Flood	12'	24.40	12.55	12.55	12'	10.07	10.97	26.47	16.38	6'	7.15	25.92	9.76	24.82
	24'	6.10	25.09	25.09	24'	20.14	2.74	52.95	32.76	12'	14.30	6.48	19.52	49.63
	36'	2.71	37.64	37.64	36'	30.21	1.22	79.42	49.14	18'	21.45	2.88	29.28	74.45
	48'	1.53	50.19	50.19	48'	40.28	0.69	105.9	65.51	24'	28.6	1.62	39.04	99.26