

GD6DR / IRD602

6" Gravity LED Lensed Downlight - Wet Location

JOB NAME		CATALOG NUMBER	
NOTES		TYPE	

ELECTRICAL DATA: (Data Based On 3000K/82CRI Configuration)

LED Light Engine	Nominal Delivered Lumens *	System Wattage **	Efficacy	LED Light Engine	Nominal Delivered Lumens *	System Wattage **	Efficacy
L1	900lm	10W	90 lm/W	L8	4200lm	43W	98 lm/W
L2	1400lm	12W	116 lm/W	L9	4850lm	49W	99 lm/W
L3	1850lm	14W	132 lm/W	L10	5500lm	50W	110 lm/W
L4	2350lm	18W	131 lm/W	L11	6400lm	60W	107 lm/W
L5	2800lm	23W	122 lm/W	L12	7350lm	74W	99 lm/W
L6	3300lm	30W	110 lm/W	L14	9150lm	87W	105 lm/W
L7	3750lm	36W	104 lm/W				

* Delivered lumen output will vary depending on CCT, CRI, optic and reflector finish. | ** System Wattage include driver and LED Module consumption.

LED LIGHT ENGINE

- 82/92 CRI, 2700K, 3000K, 3500K or 4000K
- 2 Step MacAdam (2 SDCM)
- Rated life of >50,000 hours L70 based on LED testing per LM-80-08 and projected values using IESNA TM21-11

DIMMING

- Forward/Reverse Phase Dimming 5% (120V only)
- 0-10V Dimming 1%
- EldoLED 0-10V 0.1% or 1%
- Lutron® LDE1 Hi-Lume 1% EcoSystem LED driver with Soft-on, Fade-to-Black dimming technology
- DMX512 RDM 0.1%

OPTICS

- 14° Narrow Spot, 20° Spot, 30° Narrow Flood, 40° Flood, 50° Wide Flood and 60° Very Wide Flood
- Optics and filter media are field interchangeable

ELECTRICAL SYSTEM

- Dedicated voltage options of 120V, 277V or 347V. Must be specified in catalog code
- 347V available with -D101 in L1 to L7 only, consult factory for lead times
- Multiple dimming drivers available
- This product complies with IEEE C62.41 for surge endurance up to 2.5KV. Additional surge protection recommended. Damage from power surge is not covered by warranty.

FRAME CONSTRUCTION

Constructed from 16 gauge and 18 gauge heavy duty powder coated cold rolled steel frame with a large access junction box. ETL listed for through wiring. LED light engine and driver are accessible from above or below ceiling.

REFLECTOR

Specification grade reflector with 1.5mm thickness. Reflector available in black, clear, haze or white finish. Consult factory for other colors. Lens available in two lens types; Clear Tempered or Solite. Architectural, discrete polished self flange standard. Optional painted white flange is available. Meets RP-1 requirements with controlled light distribution at a 60° cut off.

INSTALLATION

The luminaire is type Non-IC. Insulation must be kept at a minimum of 3" away from fixture. Accommodates up to 1 1/4" ceiling thickness. Universal mounting brackets included. Compatible with C-channel, flat bar, wood joist bar hanger and EMT. Bar hangers must be ordered separately. C-channel is recommended for T-bar ceilings. Max. ambient temperature: 95°F (35°C).

EMERGENCY BACKUP

Remote test switch included. External battery operates LED load of up to 7W at a minimum of 400 lumens for 90 minutes (EM7), or 20W at a minimum of 1200 lumens for 90 minutes (EM20).

LISTING / WARRANTY

- ETL Listed to US and Canadian standards for wet locations
- 5-Year Intense LED Limited Warranty

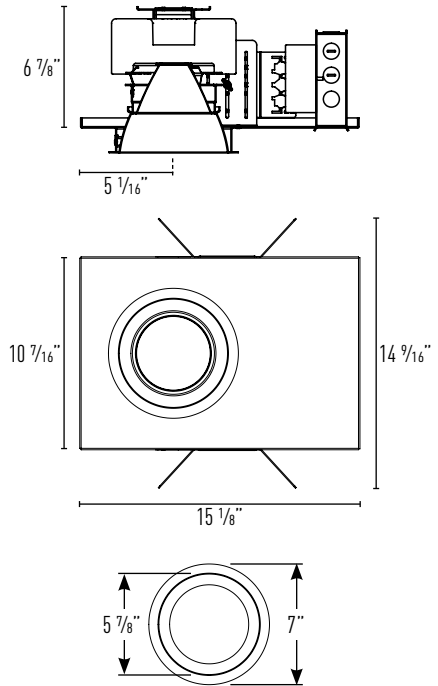

Ceiling Cut Out: 6 1/2"
Maximum Ceiling Thickness: 1 1/4"

Housing Part Number: (Example: GD6DRL327-DIM-NS)

Housing	Wattage		CCT / CRI	Dimming	Voltage	Optic	Options
GD6DR	L1 ¹ (10W)	L8 (43W)	27 (2700K/82 CRI)	-DIM ² (Phase Dimming 5%)	blank (120V)	-NS ⁴ (14° Narrow Spot)	EM7 (7W Emergency Backup w/ Remote Test Switch IOTA part #ILB-CP07-A)
	L2 ¹ (12W)	L9 (49W)	279 (2700K/92 CRI)	-D101 (0-10V Dimming 1%)	27 (277V)	-SP (20° Spot)	
	L3 (14W)	L10 (50W)	30 (3000K/82 CRI)	-ED10V1 ³ (eldoLED 0-10V 1%)	34 ⁹ (347V)	-NF (30° Narrow Flood)	
	L4 (18W)	L11 (60W)	309 (3000K/92 CRI)	-ED10V01 ³ (eldoLED 0-10V 0.1%)		-FL (40° Flood)	EM20 ¹⁰ (20W Emergency Backup w/ Remote Test Switch IOTA ILB-CP20-HE-A)
	L5 (23W)	L12 (74W)	35 (3500K/82 CRI)	-LUT ⁶ (Lutron® LDE1 EcoSystem 1%)		-WF ⁷ (50° Wide Flood)	
	L6 (30W)	L14 (87W)	359 (3500K/92 CRI)	-DMXR ⁵ (DMX512 RDM 0.1%)		-VF ⁸ (60° Very Wide Flood)	
		L7 (36W)		40 (4000K/82 CRI)			
			409 (4000K/92 CRI)				

Reflector Part Number: (Example: IRD602HZ-SF-CR)

Reflector	Reflector Finish	Lens Type
IRD602	HZ-SF (Haze, Self-Flanged)	-CR (Clear Tempered)
	HZ-SFW (Haze, Self-Flanged White)	-SL (Solite)
	W-SF (White, Self-Flanged)	
	C-SF (Clear, Self-Flanged)	
	C-SFW (Clear, Self-Flanged White)	
	B-SF ¹¹ (Black, Self-Flanged)	

Accessories

- 1100 (C-Channel Bar Hangers)
- 1200 (Flat Bar Hangers)
- 1400 (Wood Joist Bar Hangers)

Notes:

- L1 & L2 only available with -D101
- Available in 120V only and Not available with L14
- eldoLED dimming available with L3-L12
- Lutron® dimming available with L3-L8
- DMX512 RDM available with L4-L14
- 14° Optic (NS) available on L1-L9 only
- 50° for L1-L9 only accepts (1) media filter
- 60° Optic (VF) available on L10-L14 only. Accepts only one filter media accessory.
- 347V available with -D101 in L1 to L7 only, consult factory for lead times
- EM20 only available for L5 to L14
- Consult factory for lead times

JOB NAME		CATALOG NUMBER	
NOTES		TYPE	

GD6DRL3 IRD602HZ

Report #: ILL20191216-7.001 (14)
 ILL20191217-3.001 (20)
 ILL20191217-10.001 (30)
 ILL20191217-17.001 (40)
 ILL20191218-8.001 (50)

CCT MULTIPLIERS:
82 CRI **92 CRI**
 2700K (x 0.95) (x 0.79)
 3000K (x 1.00) (x 0.82)
 3500K (x 1.02) (x 0.85)
 4000K (x 1.03) (x 0.88)

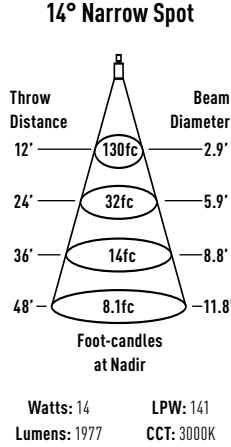

Intensity	
Degree	CBCP
0°	18684
5°	14110
15°	1644
25°	779
35°	53
45°	36

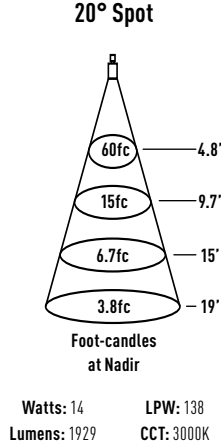

Intensity	
Degree	CBCP
0°	8686
5°	7366
15°	2622
25°	815
35°	82
45°	54

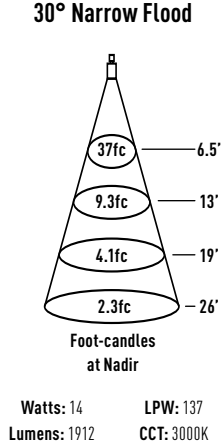

Intensity	
Degree	CBCP
0°	5343
5°	5016
15°	2695
25°	1148
35°	106
45°	37

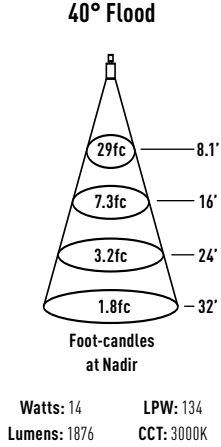

Intensity	
Degree	CBCP
0°	4200
5°	4037
15°	2684
25°	1207
35°	123
45°	54

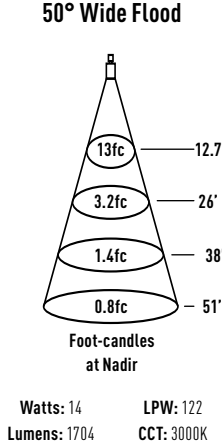

Intensity	
Degree	CBCP
0°	1843
5°	1804
15°	1532
25°	1088
35°	542
45°	197

GD6DRL4 IRD602HZ

Report #: ILL20191216-7.002 (14)
 ILL20191217-3.002 (20)
 ILL20191217-10.002 (30)
 ILL20191217-17.002 (40)
 ILL20191218-8.002 (50)

CCT MULTIPLIERS:
82 CRI **92 CRI**
 2700K (x 0.95) (x 0.79)
 3000K (x 1.00) (x 0.82)
 3500K (x 1.02) (x 0.85)
 4000K (x 1.03) (x 0.88)

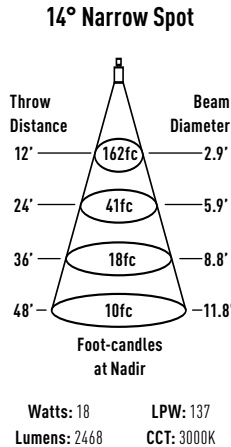

Intensity	
Degree	CBCP
0°	23324
5°	17615
15°	2052
25°	972
35°	66
45°	45

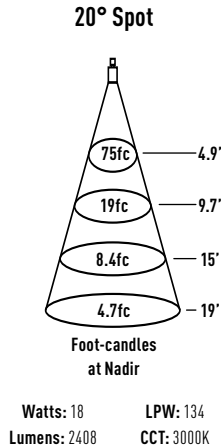

Intensity	
Degree	CBCP
0°	10843
5°	9196
15°	3273
25°	1018
35°	103
45°	67

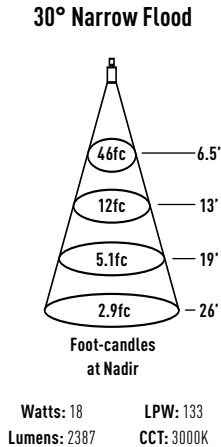

Intensity	
Degree	CBCP
0°	6670
5°	6262
15°	3364
25°	1433
35°	133
45°	47

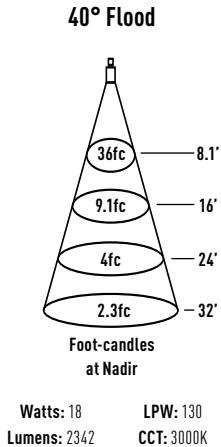

Intensity	
Degree	CBCP
0°	5243
5°	5040
15°	3351
25°	1507
35°	154
45°	67

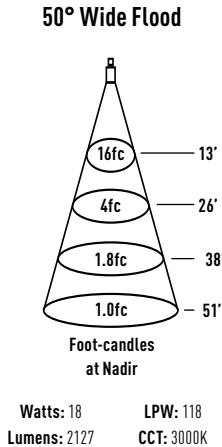

Intensity	
Degree	CBCP
0°	2301
5°	2252
15°	1913
25°	1358
35°	677
45°	246

JOB NAME		CATALOG NUMBER	
NOTES		TYPE	

GD6DRL5 IRD602HZ

Report #: ILL20191216-7.003 (14)
 ILL20191217-3.003 (20)
 ILL20191217-10.003 (30)
 ILL20191217-17.003 (40)
 ILL20191218-8.003 (50)

CCT MULTIPLIERS:

	82 CRI	92 CRI
2700K	(x 0.95)	(x 0.79)
3000K	(x 1.00)	(x 0.82)
3500K	(x 1.02)	(x 0.85)
4000K	(x 1.03)	(x 0.88)

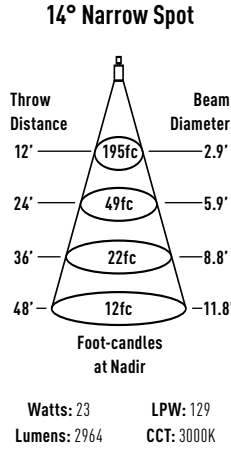

Intensity	
Degree	CBCP
0°	28005
5°	21151
15°	2464
25°	1168
35°	80
45°	54

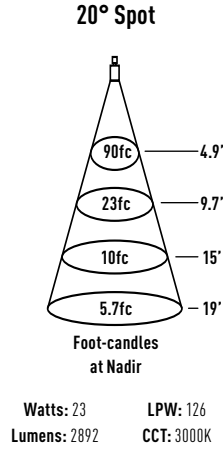

Intensity	
Degree	CBCP
0°	13019
5°	11041
15°	3930
25°	1222
35°	124
45°	81

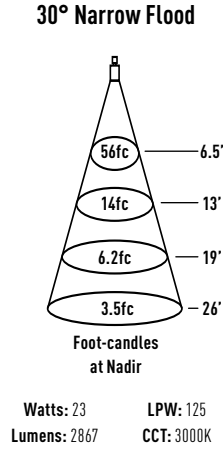

Intensity	
Degree	CBCP
0°	8009
5°	7519
15°	4040
25°	1721
35°	160
45°	56

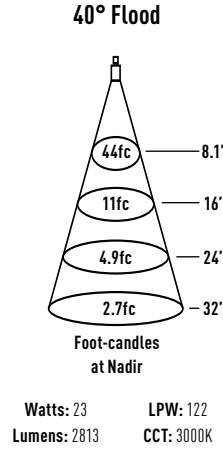

Intensity	
Degree	CBCP
0°	6296
5°	6051
15°	4023
25°	1809
35°	185
45°	81

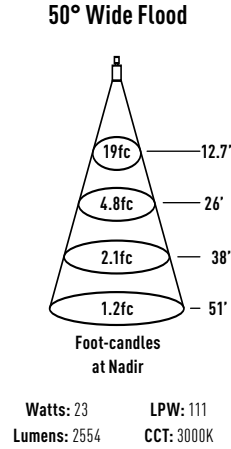

Intensity	
Degree	CBCP
0°	2763
5°	2704
15°	2297
25°	1630
35°	812
45°	295

GD6DRL6 IRD602HZ

Report #: ILL20191216-7.004 (14)
 ILL20191217-3.004 (20)
 ILL20191217-10.004 (30)
 ILL20191217-17.004 (40)
 ILL20191218-8.004 (50)

CCT MULTIPLIERS:

	82 CRI	92 CRI
2700K	(x 0.95)	(x 0.79)
3000K	(x 1.00)	(x 0.82)
3500K	(x 1.02)	(x 0.85)
4000K	(x 1.03)	(x 0.88)

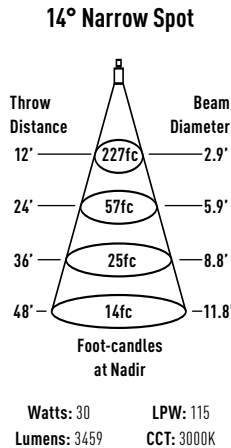

Intensity	
Degree	CBCP
0°	32686
5°	24686
15°	2876
25°	1363
35°	93
45°	64

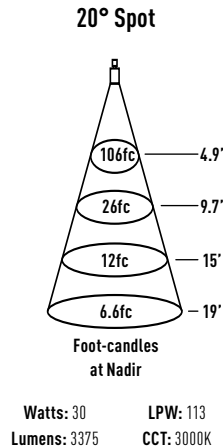

Intensity	
Degree	CBCP
0°	15195
5°	12887
15°	4586
25°	1427
35°	144
45°	94

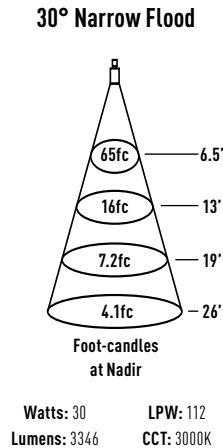

Intensity	
Degree	CBCP
0°	9347
5°	8775
15°	4715
25°	2009
35°	186
45°	65

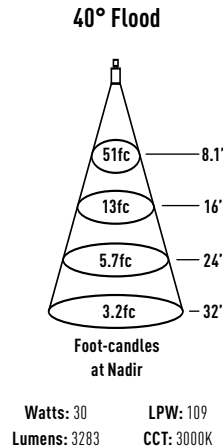

Intensity	
Degree	CBCP
0°	7348
5°	7063
15°	4696
25°	2112
35°	216
45°	94

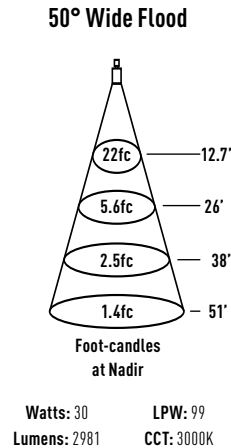

Intensity	
Degree	CBCP
0°	3224
5°	3155
15°	2681
25°	1903
35°	948
45°	344