

GRTR2

Gravity Recessed Multiple (2) Head

| | | | |
|----------|--|----------------|--|
| JOB NAME | | CATALOG NUMBER | |
| NOTES | | TYPE | |

ELECTRICAL DATA

| LED Light Engine | Wattage Per Head ¹ | CCT / CRI | Nominal Delivered Lumens ^{2,3} |
|------------------|-------------------------------|----------------|---|
| L1 | 14W | 3000K / 82 CRI | 1500lm |
| L2 | 20W | 3000K / 82 CRI | 2000lm |
| L3 | 25W | 3000K / 82 CRI | 2500lm |
| L4 | 35W | 3000K / 82 CRI | 3000lm |
| L5 | 39W | 3000K / 82 CRI | 3500lm |

⁽¹⁾ System Wattage includes driver & LED Module consumption. | ⁽²⁾ Delivered lumens will vary depending on CCT, CRI & optic | ⁽³⁾ Data shown is per individual head

LED LIGHT ENGINE

- 92 CRI & 82 CRI in 2700K, 3000K, 3500K and 4000K with 2 SDCM binning
- Rated life of > 50,000 hours L70 based on LED testing per LM-80-08 and projected values using IESNA TM21-11

OPTICS

- 14° Spot, 24° Narrow Flood, 36° Flood, 50° Wide Flood
- Field Changeable Optics

ELECTRICAL

- Dedicated voltage options of 120V or 277V. Must be specified in catalog code. Power factor >.9, 50/60Hz
- Class 2 power supply
- Over voltage, over current and short circuit protection
- This product complies with IEEE C62.41 for surge endurance up to 2.5KV. Additional surge protection recommended.
- Damage from power surge is not covered by warranty

FRAME-IN: (MUST ORDER SEPARATELY)

Frame-in is non-IC rated, must be kept at a minimum of 3" away from insulation. Frame-in is equipped with quick connect to trim assembly for easy installation. Junction box is accessible from below the ceiling.

INSTALLATION

Luminaire can accommodate up to 1 1/2" ceiling thickness. Luminaire is supplied with butterfly brackets to allow up-to 3" vertical adjustment. Compatible with C-channel, flat bar, wood joist bar and EMT. Bar hangers must be ordered separately. C-channel are recommended for T-bar ceilings. Max. ambient temperature: 95°F (35°C).

TRIM ASSEMBLY

Trim assembly includes integral power supply for each individual head. Quick connection supplied for easy installation and wiring to frame-in. Ease of installation and maintenance with access to power supply. Mounts to frame-in via heavy duty torsion springs.

SNOOT

Snoot is integral to fixture and factory installed, must be specified.

ACCESSORIES

- Luminaire will accommodate (2) lens media and/or filter
- No accessory holder required
- Must order an accessory per head, see page 2.

EMERGENCY

Remote test switch included. External battery operates LED load of up to 7W at a minimum of 750 lumens for 90 minutes. Emergency backup powers one head only.

LISTING/WARRANTY

- ETL listed to US and Canadian standards for damp locations.
- 5-Year Intense LED Limited Warranty



Gravity™

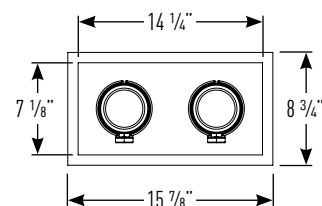

Frame-in dimensions are on Page 2

Ceiling Cut Out: 15 3/8" x 8 1/8"
Horizontal Adjustability: 360°
Vertical Adjustability: 45°

Trim: (Example: GRTR2L230-24WW)

| Trim | System Wattage | CCT / CRI | Optic | Head Finish | Flange Finish | Driver | Options |
|-------|----------------|------------------|------------------|---------------|------------------------|--|---------------------------------|
| GRTR2 | L1 (28 Watts) | 27 | (2700K / 82 CRI) | -SP (14° SP) | B ¹ (Black) | B ¹ (Black) | blank (Non-Dimming) |
| | L2 (40 Watts) | 279 | (2700K / 92 CRI) | -NF (24° NFL) | W ¹ (White) | W ¹ (White) | DELV ² (ELV Dimming) |
| | L3 (50 Watts) | 30 | (3000K / 82 CRI) | -FL (36° FL) | | | D101 (0-10V Dimming 1%) |
| | L4 (70 Watts) | 309 | (3000K / 92 CRI) | -WF (50° WFL) | | | ED10V1 (eldoLED 0-10V 1%) |
| | L5 (78 Watts) | 35 | (3500K / 82 CRI) | | | | ED10V01 (eldoLED 0-10V 0.1%) |
| | | 359 | (3500K / 92 CRI) | | | | LUT (Lutron® LDE1 EcoSystem 1%) |
| | 40 | (4000K / 82 CRI) | | | | LUT2 ² (Lutron® LTEA2W 2-Wire 1%) | |
| | 409 | (4000K / 92 CRI) | | | | | |

Frame-In: (Example: IGTM-4FK-2)

| Frame-In | Voltage | Options |
|------------|--------------|---------------------------------------|
| IGTM-4FK-2 | blank (120V) | 1100 (C-Channel Bar Hangers) |
| | 27 (277V) | 1200 (Flat Bar Hangers) |
| | | 1400 (Wood Joist Bar Hangers) |
| | | -EM7 (7W Emergency Backup) |
| | | IOTA part #ILB-CP07-A |

Notes:

- Consult factory for special order finishes
- Phase dimming in 120V only

GRTR2

Gravity Recessed Multiple (2) Head

| | | | |
|----------|--|----------------|--|
| JOB NAME | | CATALOG NUMBER | |
| NOTES | | TYPE | |

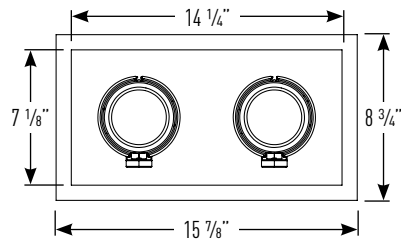
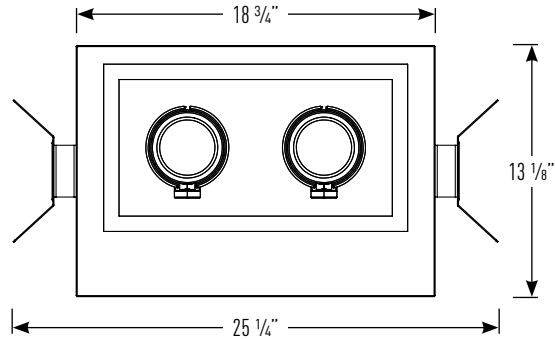
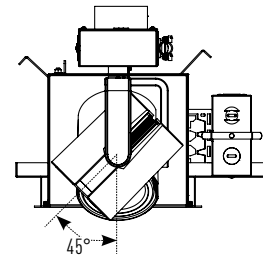
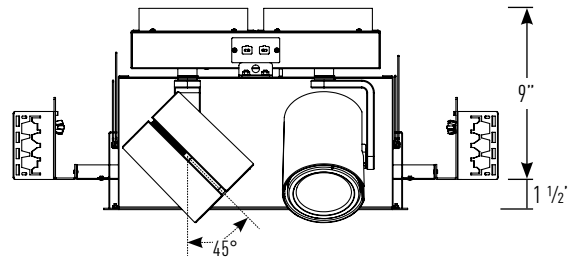

ACCESSORIES

Luminaire will accommodate (2) accessories, no accessory holder required.

INSTALLATION

1. Rotate release cap by turning counter clockwise
2. Install accessories into release cap
3. Replace release cap and secure by turning clockwise

Accessories

- PFL60-10E83 (60x10 Spread)
- PFL90-30E83 (90x30 Spread)

Optics

- IP-OP83SP (14° Spot)
- IP-OP83NF (24° Narrow Flood)
- IP-OP83FL (36° Flood)
- IP-OP83WF (50° Wide Flood)

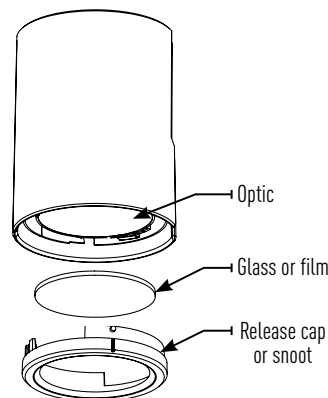

GRTR1

Gravity Recessed Multiple (1) Head

| | | | |
|----------|--|----------------|--|
| JOB NAME | | CATALOG NUMBER | |
| NOTES | | TYPE | |

GRTR1L530

Report #: ILL-20170120-04.005 (-14)
 ILL-20170119-01.005 (-24)
 ILL-20170119-02.005 (-36)
 ILL-20170120-01.005 (-50)

LED Package Multipliers:

- L1 (x 0.45)
- L2 (x 0.60)
- L3 (x 0.73)
- L4 (x 0.92)

CCT / CRI Multipliers:

- 2700K / 82 CRI (x 0.93)
- 2700K / 92 CRI (x 0.76)
- 3000K / 82 CRI (x 1.00)
- 3000K / 92 CRI (x 0.87)
- 3500K / 82 CRI (x 1.00)
- 3500K / 92 CRI (x 0.87)
- 4000K / 82 CRI (x 1.00)
- 4000K / 92 CRI (x 0.87)

Spot (-SP)

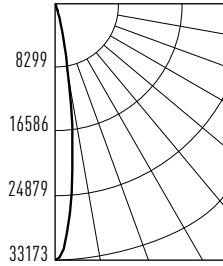

Watts: 39
 Lumens: 3406
 LPW: 87
 CCT: 3000K

Narrow Flood (-NF)

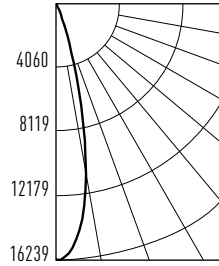

Watts: 39
 Lumens: 3509
 LPW: 90
 CCT: 3000K

Flood (-FL)

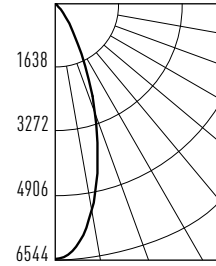

Watts: 39
 Lumens: 3368
 LPW: 86
 CCT: 3000K

Wide Flood (-WF)

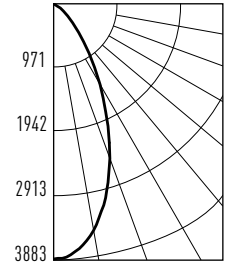

Watts: 39
 Lumens: 3286
 LPW: 84
 CCT: 3000K

Candelas at Nadir

| Degree | Candela |
|--------|---------|
| 0° | 33173 |
| 5° | 24581 |
| 15° | 3411 |
| 25° | 570 |
| 35° | 141 |
| 45° | 49 |

Candelas at Nadir

| Degree | Candela |
|--------|---------|
| 0° | 16186 |
| 5° | 14973 |
| 15° | 5592 |
| 25° | 881 |
| 35° | 208 |
| 45° | 58 |

Candelas at Nadir

| Degree | Candela |
|--------|---------|
| 0° | 6544 |
| 5° | 6258 |
| 15° | 4230 |
| 25° | 1955 |
| 35° | 698 |
| 45° | 233 |

Candelas at Nadir

| Degree | Candela |
|--------|---------|
| 0° | 3883 |
| 5° | 3783 |
| 15° | 3056 |
| 25° | 1931 |
| 35° | 1003 |
| 45° | 453 |

APPLICATION DATA:

W and **L** are the outer points where the candle power drops to 50% of maximum. **FC** are the initial foot candles at the center of the beam.

- W** Beam width
- L** Beam length
- C** Distance to center of beam
- D** Distance
- FC** Foot candles

Illuminated width & length are based upon point at which illuminance falls to 50% of center illuminance. Recommended spacing is based upon uniform illuminance aiming angle is the angle between the lamp axis and the perpendicular to the illuminated plane.

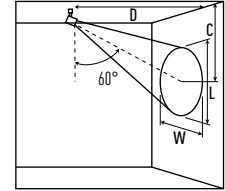
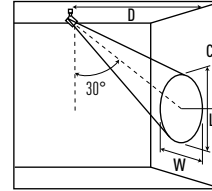
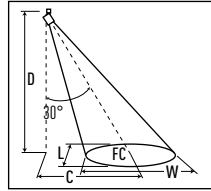
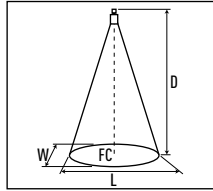

| | 0° HORIZONTAL | | | | | 30° HORIZONTAL | | | | | 30° VERTICAL | | | | | 60° VERTICAL | | | | |
|--|---------------|-----|-------|-------|--|----------------|-------|-----|-------|-------|--------------|-------|-----|-------|-------|--------------|------|------|------|------|
| | D | FC | W | L | | D | C | FC | W | L | D | C | FC | W | L | D | C | FC | W | L |
| GTML530-14 3000K Spot | 12' | 272 | 3.3' | 3.3' | | 12' | 6.9' | 150 | 4.4' | 3.8' | 3.0' | 5.2' | 461 | 1.6' | 3.5' | 3.0' | 1.7' | 2394 | 0.9' | 1.1' |
| | 14' | 200 | 3.8' | 3.8' | | 14' | 8.1' | 110 | 5.1' | 4.4' | 4.0' | 6.9' | 259 | 2.2' | 4.6' | 4.0' | 2.3' | 1347 | 1.3' | 1.5' |
| | 16' | 153 | 4.4' | 4.4' | | 16' | 9.2' | 84 | 5.9' | 5.0' | 5.0' | 8.7' | 166 | 2.7' | 5.8' | 5.0' | 2.9' | 862 | 1.6' | 1.8' |
| | 18' | 121 | 4.9' | 4.9' | | 18' | 10.4' | 67 | 6.6' | 5.7' | 6.0' | 10.4' | 115 | 3.3' | 6.9' | 6.0' | 3.5' | 599 | 1.9' | 2.2' |
| GTML530-24 3000K Narrow Flood | 12' | 112 | 5.4' | 5.4' | | 12' | 6.9' | 73 | 7.3' | 6.2' | 3.0' | 5.2' | 225 | 2.7' | 6.4' | 3.0' | 1.7' | 1168 | 1.6' | 1.8' |
| | 14' | 83 | 6.3' | 6.3' | | 14' | 8.1' | 54 | 8.5' | 7.3' | 4.0' | 6.9' | 126 | 3.6' | 8.5' | 4.0' | 2.3' | 657 | 2.1' | 2.4' |
| | 16' | 63 | 7.2' | 7.2' | | 16' | 9.2' | 41 | 9.8' | 8.3' | 5.0' | 8.7' | 81 | 4.5' | 10.6' | 5.0' | 2.9' | 421 | 2.6' | 3.0' |
| | 18' | 50 | 8.1' | 8.1' | | 18' | 10.4' | 32 | 11.0' | 9.3' | 6.0' | 10.4' | 56 | 5.4' | 12.7' | 6.0' | 3.5' | 292 | 3.1' | 3.7' |
| GTML530-36 3000K Flood | 12' | 45 | 8.2' | 8.2' | | 12' | 6.9' | 30 | 11.4' | 9.5' | 3.0' | 5.2' | 91 | 4.1' | 12.6' | 3.0' | 1.7' | 472 | 2.4' | 2.8' |
| | 14' | 33 | 9.6' | 9.6' | | 14' | 8.1' | 22 | 13.3' | 11.1' | 4.0' | 6.9' | 51 | 5.5' | 16.9' | 4.0' | 2.3' | 266 | 3.2' | 3.8' |
| | 16' | 26 | 10.9' | 10.9' | | 16' | 9.2' | 17 | 15.2' | 12.6' | 5.0' | 8.7' | 33 | 6.8' | 21.1' | 5.0' | 2.9' | 170 | 3.9' | 4.7' |
| | 18' | 20 | 12.3' | 12.3' | | 18' | 10.4' | 13 | 17.1' | 14.2' | 6.0' | 10.4' | 23 | 8.2' | 25.3' | 6.0' | 3.5' | 118 | 4.7' | 5.7' |
| GTML530-50 3000K Wide Flood | 12' | 27 | 11.1' | 11.1' | | 12' | 6.9' | 18 | 16.0' | 12.9' | 3.0' | 5.2' | 54 | 5.6' | 31.5' | 3.0' | 2' | 280 | 3.2' | 4.0' |
| | 14' | 20 | 13.0' | 13.0' | | 14' | 8.1' | 13 | 18.7' | 15.0' | 4.0' | 6.9' | 30 | 7.4' | 42.1' | 4.0' | 3' | 158 | 4.3' | 5.3' |
| | 16' | 15 | 14.9' | 14.9' | | 16' | 9.2' | 10 | 21.3' | 17.2' | 5.0' | 8.7' | 19 | 9.3' | 52.6' | 5.0' | 3' | 101 | 5.4' | 6.7' |
| | 18' | 12 | 16.7' | 16.7' | | 18' | 10.4' | 8 | 24.0' | 19.3' | 6.0' | 10.4' | 13 | 11.1' | 63.1' | 6.0' | 4' | 70 | 6.4' | 8.0' |