

SD4DR / IC432

4" SD LED Lensed Downlight - Wet Location

JOB NAME		CATALOG NUMBER	
NOTES		TYPE	

ELECTRICAL DATA

LED Light Engine	System Wattage * @ 120V	CCT	Nominal Delivered Lumens **	Efficacy
L0	8W	3500K	675 lm	84 lm/W
L1	10W	3500K	900 lm	85 lm/W
L2	14W	3500K	1300 lm	91 lm/W
L3	19W	3500K	1700 lm	90 lm/W
L4	23W	3500K	2100 lm	93 lm/W
L5	28W	3500K	2600 lm	91 lm/W
L6	33W	3500K	3000 lm	90 lm/W
L7	38W	3500K	3400 lm	90 lm/W

* System Wattage includes driver and LED Module consumption. | ** Delivered lumen output will vary depending on CCT selection.



LED MODULE / OPTICS

- 80/90 CRI at 2700K, 3000K, 3500K, 4000K with 2 SDCM
- 70% lumen maintenance at 50,000 hours
- 30° Narrow Flood, 50° Flood or 70° Wide Flood

ELECTRICAL SYSTEM

- Dedicated voltage options of 120V, 277V or 347V must be specified in catalog code.
- Phase dimming available in 120V only
- 347V available with Osram 0-10V 1% Dimming only

FRAME CONSTRUCTION

Heavy duty galvanized steel frame with a large access junction box. ETL listed for through wiring. LED light engine and driver are accessible from above or below ceiling.

INSTALLATION

The luminaire is type Non-IC. Insulation must be kept at a minimum of 3" away from fixture. Universal mounting brackets included. Compatible with C-channel, flat bar, wood joist bar hanger and EMT. Bar hangers must be ordered separately. C-channel is recommended for T-bar ceilings. Maximum ceiling thickness is 1 1/4". Max. ambient temperature: 95°F (35°C).

REFLECTOR

Specification grade reflector with 1.2mm thickness. Reflector available in clear specular, haze or white. Architectural, discrete polished self flange standard. Optional painted white flange is available. Meets RP-1 requirements with controlled light distribution at a 50° cut off.

DIMMING

- 0-10V Dimming 1%
- Phase Dimming 120V only, Forward 1% / Reverse 5% EtoLED 0-10V 0.1% or 1%
- Lutron® LDE1 Hi-Lume 1% EcoSystem LED driver with Soft-on, Fade-to-Black dimming technology
- DMX512 RDM 0.1%

EMERGENCY BACKUP

Remote test switch included. External battery operates LED load of up to 7W at a minimum of 550 lumens for 90 minutes (EM7), or 20W at a minimum of 1600 lumens for 90 minutes (EM20).

intellect™

- Integrated control system provides occupancy and light level detection, and controls the load directly by the power control module Integrated intelligent fixture controls
- Visit Leviton [intellect™](#) for more info

LISTING/WARRANTY

- ETL listed to US and Canadian standards for wet locations.
- 5-Year Intense LED Limited Warranty
- ENERGY STAR® Qualified¹⁰

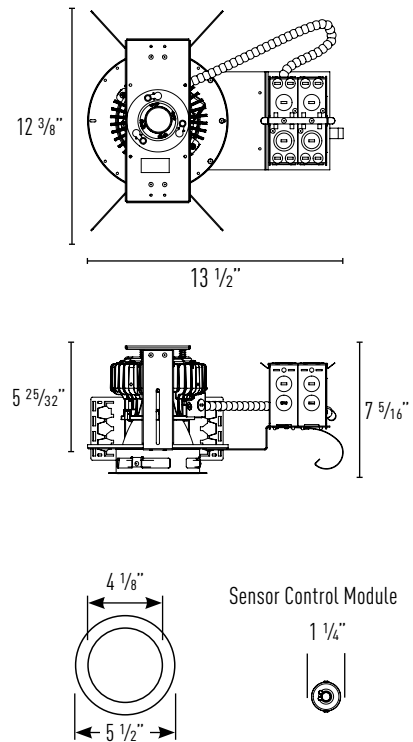

Ceiling Cut Out: 4 3/4"
Maximum Ceiling Thickness: 1 1/4"

Housing Part Number (Example: SD4DRL4359-D101-NFEM7)

Housing	LED Module	CCT / CRI	Dimming	Voltage	Optic	Options
SD4DR	L0 ¹ (8W)	27 (2700K / 80 CRI)	-D101 (Osram 0-10V 1%)	blank (120V)	-NF (30°)	EM7 (7W Emergency Backup w/ Remote Test Switch IOTA part #ILB-CP07-A)
	L1 (10W)	279 (2700K / 90 CRI)	-IE ³ (Intellect Wireless 1%)	27 (277V)	-FL (50°)	
	L2 (14W)	30 (3000K / 80 CRI)	-DIM ^{4,5} (Phase Dimming)	34 ⁶ (347V)	-WF (70°)	EM20 ⁹ (20W Emergency Backup w/ Remote Test Switch IOTA ILB-CP20-HE-S)
	L3 (19W)	309 (3000K / 90 CRI)	-ED10V1 (eldoLED 0-10V 1%)			
	L4 (23W)	35 (3500K / 80 CRI)	-ED10V01 (eldoLED 0-10V 0.1%)			
	L5 (28W)	359 (3500K / 90 CRI)	-LUT ⁸ (Lutron® LDE1 EcoSystem 1%)			
	L6 (33W)	40 (4000K / 80 CRI)	-DMXR ⁷ (DMX512 RDM 0.1%)			
L7 ² (38W)	409 (4000K / 90 CRI)					

Reflector Part Number (Example: IC432HZ-SF-CR)

Reflector	Reflector Finish	Lens Type
IC432	C-SF (Clear, Self Flanged)	-CR (Clear Tempered)
	C-SFW (Clear, Self Flanged White)	-SB (Sand Blasted)
	HZ-SF (Haze, Self Flanged)	
	HZ-SFW (Haze, Self Flanged White)	

Accessories

- I100 (C-Channel Bar Hangers)
- I200 (Flat Bar Hangers)
- I400 (Wood Joist Bar Hangers)

Notes:

- L0 only available with -D101
- 347V Not available with L7 option
- Intellect not available with eldoLED, Lutron, Dali or DMX Dimming (Integrated intellect control system includes sensor and power pack. Keypad Room Controller must be specified separately)
- Not available in L1, L2 or L7
- Not available in 277V
- Lutron not available in L1 & L2
- DMX512 RDM not available in L1 & L2
- 347V only available with Osram 0-10V 1% Dimming
- 20W emergency not available in L1, L2 & L3
- ENERGY STAR® Qualified (0-10V & ELV only. Excludes CCT/CRI options 279, 309 & 359)

SD4DR / IC432

4" SD LED Lensed Downlight - Wet Location

JOB NAME		CATALOG NUMBER	
NOTES		TYPE	

Electrical Table					
Lumen Package	Voltage	Wattage	VA	Input Current	Power Factor
L0	120	7.43	7.99	0.07	0.930
	277	8.41	11.87	0.04	0.709
L1	120	9.75	10.37	0.09	0.94
	277	10.82	14.18	0.05	0.76
L2	120	13.71	14.35	0.12	0.96
	277	14.85	18.06	0.07	0.82
L3	120	18.27	18.54	0.15	0.99
	277	19.77	22.92	0.08	0.86
L4	120	22.74	23.04	0.19	0.99
	277	24.09	27.31	0.10	0.88
L5	120	27.18	27.44	0.23	0.99
	277	28.93	32.00	0.12	0.90
L6	120	32.76	32.84	0.27	1.00
	277	34.09	36.72	0.13	0.93
L7	120	37.71	37.79	0.31	1.00
	277	38.86	41.77	0.15	0.93

SD4DR / IC432

4" SD LED Lensed Downlight - Wet Location

JOB NAME		CATALOG NUMBER	
NOTES		TYPE	

SD4DRL135 IC432-CR

CCT MULTIPLIERS:

	80 CRI	90 CRI
2700K	(x 0.92)	(x 0.79)
3000K	(x 0.98)	(x 0.79)
3500K	(x 1.00)	(x 0.82)
4000K	(x 1.01)	(x 0.84)

FINISH MULTIPLIERS

	30°	50°	70°
Clear	(x 1.00)	(x 1.00)	(x 1.00)
Haze	(x 0.96)	(x 0.96)	(x 0.88)
White	(x 0.96)	(x 0.97)	(x 0.90)

LENS MULTIPLIERS

	30°	50°	70°
CR	(x 1.00)	(x 1.00)	(x 1.00)
SB	(x 0.92)	(x 0.92)	(x 0.93)

-NF (30° Narrow Flood)

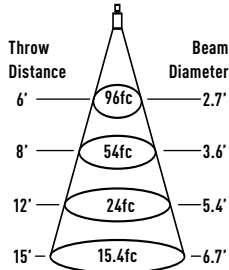

Footcandles at Nadir

Watts: 10 LPW: 87.8
Lumens: 878 CCT: 3500K

Luminance	
Degree	CBCP
0°	3458
5°	3033
15°	1331
25°	370
35°	68
45°	15

-FL (50° Flood)

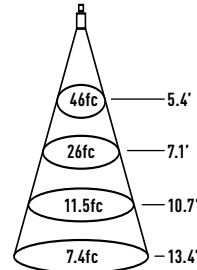

Footcandles at Nadir

Watts: 10 LPW: 94.4
Lumens: 944 CCT: 3500K

Luminance	
Degree	CBCP
0°	1658
5°	1794
15°	1336
25°	745
35°	84
45°	15

-WF (70° Wide Flood)

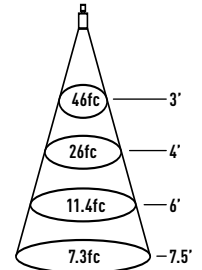

Footcandles at Nadir

Watts: 10 LPW: 74
Lumens: 740 CCT: 3500K

Luminance	
Degree	CBCP
0°	1644
5°	1268
15°	768
25°	472
35°	191
45°	50

SD4DRL235 IC43S2-CR

CCT MULTIPLIERS:

	80 CRI	90 CRI
2700K	(x 0.92)	(x 0.79)
3000K	(x 0.98)	(x 0.79)
3500K	(x 1.00)	(x 0.82)
4000K	(x 1.01)	(x 0.84)

FINISH MULTIPLIERS

	30°	50°	70°
Clear	(x 1.00)	(x 1.00)	(x 1.00)
Haze	(x 0.96)	(x 0.96)	(x 0.88)
White	(x 0.96)	(x 0.97)	(x 0.90)

LENS MULTIPLIERS

	30°	50°	70°
CR	(x 1.00)	(x 1.00)	(x 1.00)
SB	(x 0.92)	(x 0.92)	(x 0.93)

-NF (30° Narrow Flood)

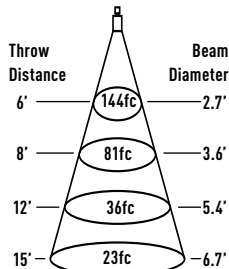

Footcandles at Nadir

Watts: 14 LPW: 94.1
Lumens: 1317 CCT: 3500K

Luminance	
Degree	CBCP
0°	5187
5°	4550
15°	1997
25°	556
35°	102
45°	23

-FL (50° Flood)

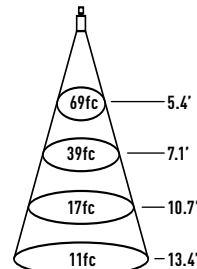

Footcandles at Nadir

Watts: 14 LPW: 128.8
Lumens: 1417 CCT: 3500K

Luminance	
Degree	CBCP
0°	2486
5°	2692
15°	2003
25°	1117
35°	126
45°	23

-WF (70° Wide Flood)

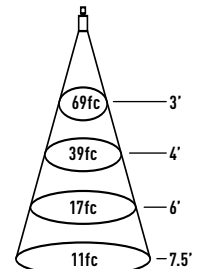

Footcandles at Nadir

Watts: 14 LPW: 79.2
Lumens: 1109 CCT: 3500K

Luminance	
Degree	CBCP
0°	2466
5°	1902
15°	1153
25°	708
35°	286
45°	75

SD4DR / IC432

4" SD LED Lensed Downlight - Wet Location

JOB NAME		CATALOG NUMBER	
NOTES		TYPE	

SD4DRL335 IC432-CR

CCT MULTIPLIERS:

	80 CRI	90 CRI
2700K	(x 0.92)	(x 0.79)
3000K	(x 0.98)	(x 0.79)
3500K	(x 1.00)	(x 0.82)
4000K	(x 1.01)	(x 0.84)

FINISH MULTIPLIERS

	30°	50°	70°
Clear	(x 1.00)	(x 1.00)	(x 1.00)
Haze	(x 0.96)	(x 0.96)	(x 0.88)
White	(x 0.96)	(x 0.97)	(x 0.90)

LENS MULTIPLIERS

	30°	50°	70°
CR	(x 1.00)	(x 1.00)	(x 1.00)
SB	(x 0.92)	(x 0.92)	(x 0.93)

-NF (30° Narrow Flood)

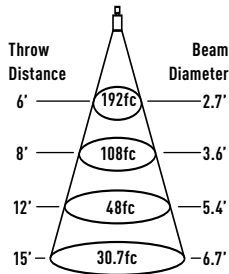

Footcandles at Nadir

Watts: 19 LPW: 92.3
Lumens: 1753 CCT: 3500K

Luminance	
Degree	CBCP
0°	6903
5°	6055
15°	2657
25°	739
35°	135
45°	30

-FL (50° Flood)

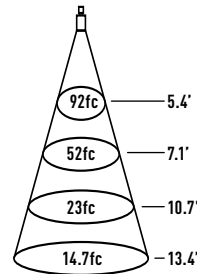

Footcandles at Nadir

Watts: 19 LPW: 99.2
Lumens: 1885 CCT: 3500K

Luminance	
Degree	CBCP
0°	3310
5°	3582
15°	2667
25°	1487
35°	168
45°	30

-WF (70° Wide Flood)

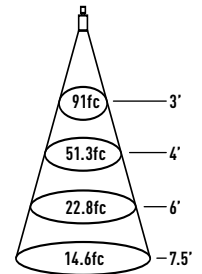

Footcandles at Nadir

Watts: 19 LPW: 77.7
Lumens: 1477 CCT: 3500K

Luminance	
Degree	CBCP
0°	3282
5°	2532
15°	1534
25°	943
35°	381
45°	100

SD4DRL435 IC432-CR

CCT MULTIPLIERS:

	80 CRI	90 CRI
2700K	(x 0.92)	(x 0.79)
3000K	(x 0.98)	(x 0.79)
3500K	(x 1.00)	(x 0.82)
4000K	(x 1.01)	(x 0.84)

FINISH MULTIPLIERS

	30°	50°	70°
Clear	(x 1.00)	(x 1.00)	(x 1.00)
Haze	(x 0.96)	(x 0.96)	(x 0.88)
White	(x 0.96)	(x 0.97)	(x 0.90)

LENS MULTIPLIERS

	30°	50°	70°
CR	(x 1.00)	(x 1.00)	(x 1.00)
SB	(x 0.92)	(x 0.92)	(x 0.93)

-NF (30° Narrow Flood)

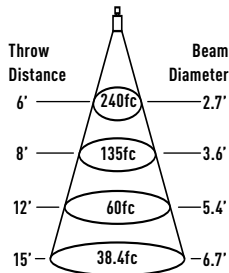

Footcandles at Nadir

Watts: 23 LPW: 95.3
Lumens: 2192 CCT: 3500K

Luminance	
Degree	CBCP
0°	8632
5°	7572
15°	3323
25°	925
35°	169
45°	38

-FL (50° Flood)

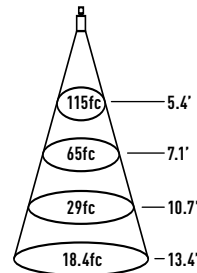

Footcandles at Nadir

Watts: 23 LPW: 102.5
Lumens: 2358 CCT: 3500K

Luminance	
Degree	CBCP
0°	4138
5°	4480
15°	3334
25°	1859
35°	210
45°	37

-WF (70° Wide Flood)

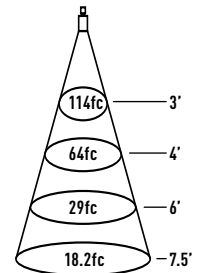

Footcandles at Nadir

Watts: 23 LPW: 80.3
Lumens: 1846 CCT: 3500K

Luminance	
Degree	CBCP
0°	4104
5°	3166
15°	1919
25°	1179
35°	476
45°	125zz