

SD4DS / ICS430

4" SD LED Square Downlight

JOB NAME		CATALOG NUMBER	
NOTES		TYPE	

ELECTRICAL DATA

LED Light Engine	System Wattage* @ 120V	CCT	Nominal Delivered Lumens**	Efficacy
L0	8W	3500K	750 lm	94 lm/W
L1	10W	3500K	1000 lm	97 lm/W
L2	14W	3500K	1500 lm	104 lm/W
L3	19W	3500K	2000 lm	102 lm/W
L4	23W	3500K	2400 lm	105 lm/W
L5	28W	3500K	2900 lm	104 lm/W
L6	33W	3500K	3400 lm	103 lm/W
L7	38W	3500K	3900 lm	102 lm/W

*System Wattage includes driver and LED Module consumption. | **Delivered lumen output will vary depending on CCT selection.

LED MODULE / OPTICS

- 80/90 CRI at 2700K, 3000K, 3500K, 4000K with 2 SDCM
- 70% lumen maintenance at 50,000 hours
- 30° Narrow Flood, 50° Flood or 70° Wide Flood

REFLECTOR

Specification grade reflector with 1.2mm thickness. Architectural, discrete polished self flange standard. Optional painted white flange is available. Meets RP-1 requirements with controlled light distribution at a 50° cut off.

intellect™

- Integrated control system provides occupancy and light level detection, and controls the load directly by the power control module Integrated intelligent fixture controls
- Visit Leviton [intellect™](#) for more info

ELECTRICAL SYSTEM

- Dedicated voltage options of 120V, 277V or 347V must be specified in catalog code.
- Phase dimming available in 120V only
- 347V available with Osram 0-10V 1% Dimming only

DIMMING

- 0-10V Dimming 1%
- Phase Dimming 120V only, Forward 1% / Reverse 5%
- EldoLED 0-10V 0.1% or 1%
- Lutron® LDE1 Hi-Lume 1% EcoSystem LED driver with Soft-on, Fade-to-Black dimming technology
- DMX512 RDM 0.1%

LISTING/WARRANTY

- ETL listed to US and Canadian standards for damp locations.
- 5-Year Intense LED Limited Warranty
- ENERGY STAR® Qualified¹⁰



FRAME CONSTRUCTION

Heavy duty galvanized steel frame with a large access junction box. ETL listed for through wiring. LED light engine and driver are accessible from above or below ceiling.

EMERGENCY BACKUP

External battery operates LED load of up to 7W at a minimum of 800 lumens for 90 minutes (EM7), or 20W at a minimum of 2300 lumens for 90 minutes (EM20). Available with remote or integral test switch, must specify.

INSTALLATION

The luminaire is type Non-IC. Insulation must be kept at a minimum of 3" away from fixture. Universal mounting brackets included. Compatible with C-channel, flat bar, wood joist bar hanger and EMT. Bar hangers must be ordered separately. C-channel is recommended for T-bar ceilings. Maximum ceiling thickness is 1 1/4". Max. ambient temperature: 95°F (35°C).

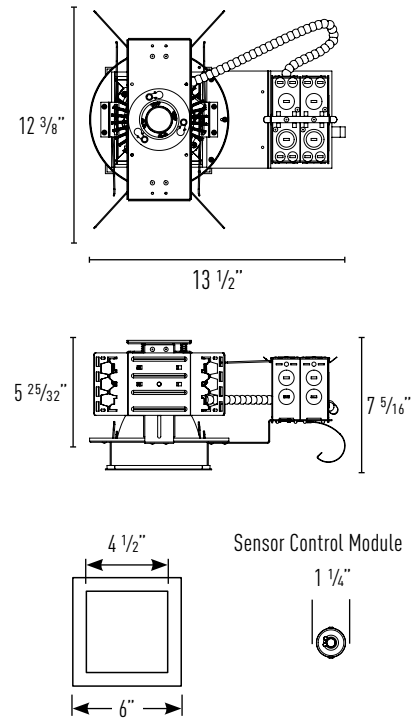

Ceiling Cut Out: 5 5/8" x 5 5/8"
Maximum Ceiling Thickness: 1 1/4"

Housing Part Number (Example: SD4DSL4359-D101-NFEM7)

Housing	LED Module	CCT / CRI	Dimming	Voltage	Optic	Options
SD4DS	L0 ¹ (8W)	27 (2700K / 80 CRI)	-D101 (Osram 0-10V 1%)	blank (120V)	-NF (30°)	EM7 (7W Emergency Backup w/ Remote Test Switch [OTA part #ILB-CP07-A])
	L1 (10W)	279 (2700K / 90 CRI)	-IE ³ (Intellect Wireless 1%)	27 (277V)	-FL (50°)	
	L2 (14W)	30 (3000K / 80 CRI)	-DIM ^{4,5} (Phase Dimming)	34 ⁸ (347V)	-WF (70°)	EM7T (7W Emergency Unit w/ Integral Test Switch [OTA part #ILB-CP07-R])
	L3 (19W)	309 (3000K / 90 CRI)	-ED10V1 (eldoLED 0-10V 1%)			EM20 ⁹ (20W Emergency Backup w/ Remote Test Switch [OTA ILB-CP20-HE-S])
	L4 (23W)	35 (3500K / 80 CRI)	-ED10V01 (eldoLED 0-10V 0.1%)			
	L5 (28W)	359 (3500K / 90 CRI)	-LUT ⁶ (Lutron® LDE1 EcoSystem 1%)			
	L6 (33W)	40 (4000K / 80 CRI)	-DMXR ⁷ (DMX512 RDM 0.1%)			
L7 ² (38W)	409 (4000K / 90 CRI)					

Notes:

- L0 only available with -D101
- 347V Not available with L7 option
- Intellect not available with eldoLED, Lutron, Dali or DMX Dimming (Integrated intellect control system includes sensor and power pack. Keypad Room Controller must be specified separately)
- Not available in L1 & L2
- Not available in 277V
- Lutron not available in L1 & L7
- DMX512 RDM not available in L1 & L2
- 347V only available with Osram 0-10V 1% Dimming
- 20W emergency not available in L1, L2 & L3
- ENERGY STAR® Qualified (0-10V & ELV only. Excludes CCT/CRI options 279, 309 & 359)

Reflector Part Number (Example: ICS430HZ-SFEM7T)

Reflector	Reflector Finish	Trim	Option
ICS430	HZ (Haze)	-SF (Self Flanged) -SFW (Self Flanged White)	EM7T (Integral Test Switch)

Accessories

- I100 (C-Channel Bar Hangers)
- I200 (Flat Bar Hangers)
- I400 (Wood Joist Bar Hangers)

SS-DOWNLIGHTING LUM-053124 P-9

INTENSE LIGHTING | 3340 E La Palma Ave, Anaheim, CA 92806 | tel 714 630-9877 | fax 714 630-9883

For Intense Lighting's limited product warranty, go to [www.intenselighting.com](#). For a printed copy of the warranty, you may call 800 961-5321.

© 2024 Intense Lighting, LLC. All rights reserved. Note: This document is subject to change without notice.

SD4DS / ICS430

4" SD LED Square Downlight

JOB NAME		CATALOG NUMBER	
NOTES		TYPE	

Electrical Table					
Lumen Package	Voltage	Wattage	VA	Input Current	Power Factor
L0	120	7.43	7.99	0.07	0.930
	277	8.41	11.87	0.04	0.709
L1	120	9.75	10.37	0.09	0.94
	277	10.82	14.18	0.05	0.76
L2	120	13.71	14.35	0.12	0.96
	277	14.85	18.06	0.07	0.82
L3	120	18.27	18.54	0.15	0.99
	277	19.77	22.92	0.08	0.86
L4	120	22.74	23.04	0.19	0.99
	277	24.09	27.31	0.10	0.88
L5	120	27.18	27.44	0.23	0.99
	277	28.93	32.00	0.12	0.90
L6	120	32.76	32.84	0.27	1.00
	277	34.09	36.72	0.13	0.93
L7	120	37.71	37.79	0.31	1.00
	277	38.86	41.77	0.15	0.93

SD4DS / ICS430

4" SD LED Square Downlight

JOB NAME		CATALOG NUMBER	
NOTES		TYPE	

SD4DSL1358 ICS430-HZ

CCT MULTIPLIERS:

	80 CRI	90 CRI
2700K	(x 0.92)	(x 0.79)
3000K	(x 0.98)	(x 0.79)
3500K	(x 1.00)	(x 0.82)
4000K	(x 1.01)	(x 0.84)

-NF (30° Narrow Flood)

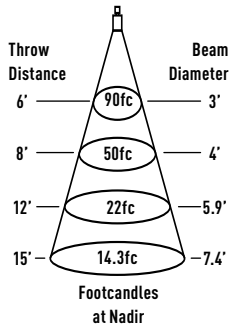

Watts: 10 LPW: 97.3
Lumens: 973 CCT: 3500K

Luminance	
Degree	CBCP
0°	3225
5°	2955
15°	1479
25°	459
35°	97
45°	17

-FL (50° Flood)

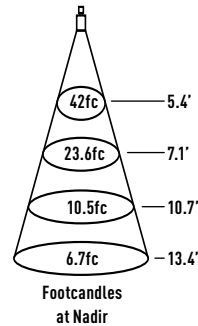

Watts: 10 LPW: 104.8
Lumens: 1048 CCT: 3500K

Luminance	
Degree	CBCP
0°	1513
5°	1499
15°	1425
25°	866
35°	110
45°	15

-WF (70° Wide Flood)

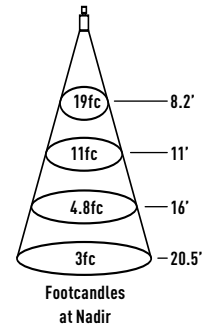

Watts: 10 LPW: 89
Lumens: 890 CCT: 3500K

Luminance	
Degree	CBCP
0°	685
5°	679
15°	639
25°	567
35°	310
45°	89

SD4DSL2358 ICS430-HZ

CCT MULTIPLIERS:

	80 CRI	90 CRI
2700K	(x 0.92)	(x 0.79)
3000K	(x 0.98)	(x 0.79)
3500K	(x 1.00)	(x 0.82)
4000K	(x 1.01)	(x 0.84)

-NF (30° Narrow Flood)

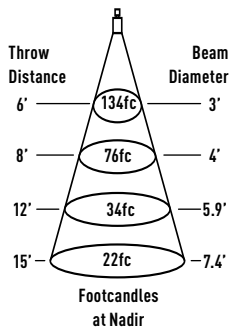

Watts: 14 LPW: 104.2
Lumens: 1459 CCT: 3500K

Luminance	
Degree	CBCP
0°	4838
5°	4432
15°	2218
25°	689
35°	145
45°	25

-FL (50° Flood)

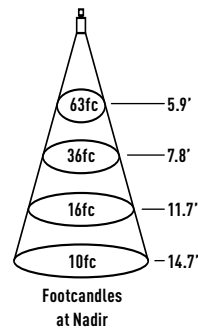

Watts: 14 LPW: 112.2
Lumens: 1571 CCT: 3500K

Luminance	
Degree	CBCP
0°	2269
5°	2249
15°	2138
25°	1299
35°	165
45°	23

-WF (70° Wide Flood)

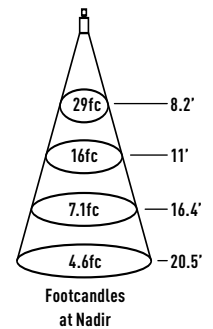

Watts: 14 LPW: 95.4
Lumens: 1335 CCT: 3500K

Luminance	
Degree	CBCP
0°	1028
5°	1018
15°	959
25°	851
35°	464
45°	134

SD4DS / ICS430

4" SD LED Square Downlight

JOB NAME		CATALOG NUMBER	
NOTES		TYPE	

SD4DSL3358 IC430-HZ

CCT MULTIPLIERS:

	80 CRI	90 CRI
2700K	(x 0.92)	(x 0.79)
3000K	(x 0.98)	(x 0.79)
3500K	(x 1.00)	(x 0.82)
4000K	(x 1.01)	(x 0.84)

-NF (30° Narrow Flood)

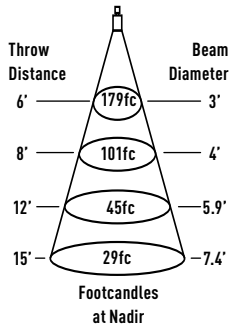

Watts: 19 LPW: 102.3
Lumens: 1943 CCT: 3500K

Luminance	
Degree	CBCP
0°	6439
5°	5900
15°	2952
25°	917
35°	193
45°	34

-FL (50° Flood)

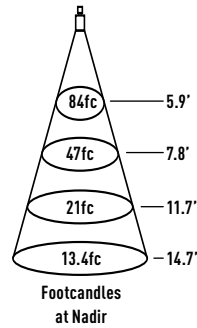

Watts: 19 LPW: 110.1
Lumens: 2092 CCT: 3500K

Luminance	
Degree	CBCP
0°	3021
5°	2993
15°	2846
25°	1729
35°	220
45°	31

-WF (70° Wide Flood)

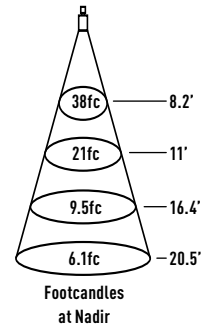

Watts: 19 LPW: 93.5
Lumens: 1776 CCT: 3500K

Luminance	
Degree	CBCP
0°	1368
5°	1355
15°	1276
25°	1132
35°	618
45°	178

SD4DSL4358 IC430-HZ

CCT MULTIPLIERS:

	80 CRI	90 CRI
2700K	(x 0.92)	(x 0.79)
3000K	(x 0.98)	(x 0.79)
3500K	(x 1.00)	(x 0.82)
4000K	(x 1.01)	(x 0.84)

-NF (30° Narrow Flood)

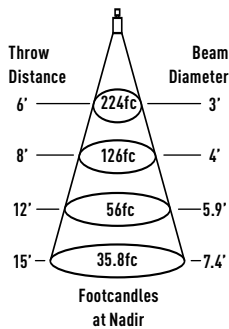

Watts: 23 LPW: 105.6
Lumens: 2429 CCT: 3500K

Luminance	
Degree	CBCP
0°	8052
5°	7377
15°	3691
25°	1147
35°	241
45°	42

-FL (50° Flood)

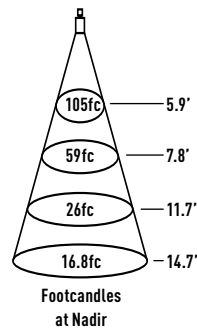

Watts: 23 LPW: 113.7
Lumens: 2615 CCT: 3500K

Luminance	
Degree	CBCP
0°	3777
5°	3743
15°	3558
25°	2162
35°	275
45°	38

-WF (70° Wide Flood)

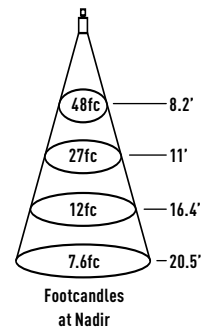

Watts: 23 LPW: 96.6
Lumens: 2221 CCT: 3500K

Luminance	
Degree	CBCP
0°	1711
5°	1694
15°	1595
25°	1416
35°	773
45°	223