

# SD4DS / ICS432

## 4" SD LED Square Lensed Downlight - Wet Location

JOB NAME		CATALOG NUMBER	
NOTES		TYPE	

### ELECTRICAL DATA

LED Light Engine	System Wattage* @ 120V	CCT	Nominal Delivered Lumens**	Efficacy
L0	8W	3500K	675 lm	84 lm/W
L1	10W	3500K	900 lm	86 lm/W
L2	14W	3500K	1300 lm	92 lm/W
L3	19W	3500K	1700 lm	90 lm/W
L4	23W	3500K	1400 lm	93 lm/W
L5	28W	3500K	2600 lm	92 lm/W
L6	33W	3500K	3000 lm	91 lm/W
L7	38W	3500K	3400 lm	90 lm/W

\*System Wattage includes driver and LED Module consumption. | \*\*Delivered lumen output will vary depending on CCT selection.

### LED MODULE / OPTICS

- 80/90 CRI at 2700K, 3000K, 3500K, 4000K with 2 SDCM
- 70% lumen maintenance at 50,000 hours
- 30° Narrow Flood, 50° Flood or 70° Wide Flood

### ELECTRICAL SYSTEM

- Dedicated voltage options of 120V, 277V or 347V must be specified in catalog code.
- Phase dimming available in 120V only
- 347V available with Osram 0-10V 1% Dimming only

### FRAME CONSTRUCTION

Heavy duty galvanized steel frame with a large access junction box. ETL listed for through wiring. LED light engine and driver are accessible from above or below ceiling.

### INSTALLATION

The luminaire is type Non-IC. Insulation must be kept at a minimum of 3" away from fixture. Universal mounting brackets included. Compatible with C-channel, flat bar, wood joist bar hanger and EMT. Bar hangers must be ordered separately. C-channel is recommended for T-bar ceilings. Maximum ceiling thickness is 1 1/4". Max. ambient temperature: 95°F (35°C).

### REFLECTOR

Specification grade reflector with 1.2mm thickness. Reflector available in clear specular, haze or white. Architectural, discrete polished self flange standard. Optional painted white flange is available. Meets RP-1 requirements with controlled light distribution at a 50° cut off.

### DIMMING

- 0-10V Dimming 1%
- Phase Dimming 120V only, Forward 1% / Reverse 5%
- EldoLED 0-10V 0.1% or 1%
- Lutron® LDE1 Hi-Lume 1% EcoSystem LED driver with Soft-on, Fade-to-Black dimming technology
- DMX512 RDM 0.1%

### intellect™

- Integrated control system provides occupancy and light level detection, and controls the load directly by the power control module Integrated intelligent fixture controls
- Visit Leviton [intellect™](#) for more info

### LISTING/WARRANTY

- ETL listed to US and Canadian standards for wet locations.
- 5-Year Intense LED Limited Warranty
- ENERGY STAR® Qualified<sup>10</sup>



### EMERGENCY BACKUP

Remote test switch included. External battery operates LED load of up to 7W at a minimum of 550 lumens for 90 minutes (EM7), or 20W at a minimum of 1600 lumens for 90 minutes (EM20).

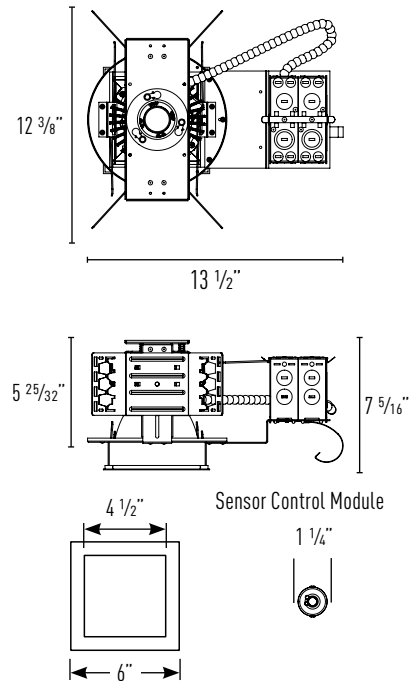
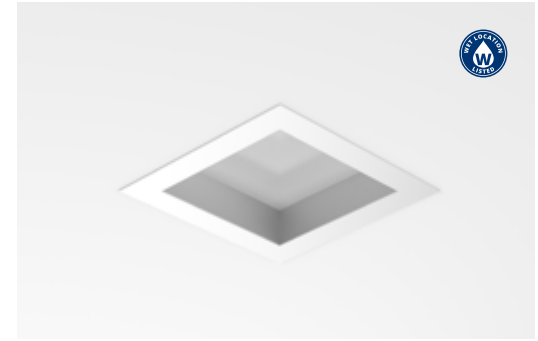

Ceiling Cut Out: 5 5/8" x 5 5/8"  
Maximum Ceiling Thickness: 1 1/4"

### Housing Part Number (Example: SD4DSL4359-D101-NFEM7)

Housing	LED Module	CCT / CRI	Dimming	Voltage	Optic	Options
SD4DS	L0 <sup>1</sup> (8W)	27 (2700K / 80 CRI)	-D101 (Osram 0-10V 1%)	blank (120V)	-NF (30°)	EM7 (7W Emergency Backup w/ Remote Test Switch <a href="#">[OTA part #ILB-CP07-A]</a> )
	L1 (10W)	279 (2700K / 90 CRI)	-IE <sup>3</sup> (Intellect Wireless 1%)	27 (277V)	-FL (50°)	
	L2 (14W)	30 (3000K / 80 CRI)	-DIM <sup>4,5</sup> (Phase Dimming)	34 <sup>8</sup> (347V)	-WF (70°)	EM20 <sup>9</sup> (20W Emergency Backup w/ Remote Test Switch <a href="#">[OTA ILB-CP20-HE-S]</a> )
	L3 (19W)	309 (3000K / 90 CRI)	-ED10V1 (eldoLED 0-10V 1%)			
	L4 (23W)	35 (3500K / 80 CRI)	-ED10V01 (eldoLED 0-10V 0.1%)			
	L5 (28W)	359 (3500K / 90 CRI)	-LUT <sup>6</sup> (Lutron® LDE1 EcoSystem 1%)			
	L6 (33W)	40 (4000K / 80 CRI)	-DMXR <sup>7</sup> (DMX512 RDM 0.1%)			
L7 <sup>2</sup> (38W)	409 (4000K / 90 CRI)					

### Notes:

- L0 only available with -D101
- 347V Not available with L7 option
- Intellect not available with eldoLED, Lutron, Dali or DMX Dimming (Integrated intellect control system includes sensor and power pack. Keypad Room Controller must be specified separately)
- Not available in L1 & L2
- Not available in 277V
- Lutron not available in L1 & L7
- DMX512 RDM not available in L1 & L2
- 347V only available with Osram 0-10V 1% Dimming
- 20W emergency not available in L1, L2 & L3
- ENERGY STAR® Qualified (0-10V & ELV only. Excludes CCT/CRI options 279, 309 & 359)

### Reflector Part Number (Example: ICS432HZ-SF-PR)

Reflector	Reflector Finish	Trim	Lens Type
ICS432	HZ (Haze)	-SF (Self Flanged)	-PR (Prismatic Spread)
		-SF <sup>W</sup> (Self Flanged White)	

### Accessories

- I100 (C-Channel Bar Hangers)
- I200 (Flat Bar Hangers)
- I400 (Wood Joist Bar Hangers)

# SD4DS / ICS432

4" SD LED Square Lensed Downlight - Wet Location

<b>JOB NAME</b>		<b>CATALOG NUMBER</b>	
<b>NOTES</b>		<b>TYPE</b>	

Electrical Table					
Lumen Package	Voltage	Wattage	VA	Input Current	Power Factor
L0	120	7.43	7.99	0.07	0.930
	277	8.41	11.87	0.04	0.709
L1	120	9.75	10.37	0.09	0.94
	277	10.82	14.18	0.05	0.76
L2	120	13.71	14.35	0.12	0.96
	277	14.85	18.06	0.07	0.82
L3	120	18.27	18.54	0.15	0.99
	277	19.77	22.92	0.08	0.86
L4	120	22.74	23.04	0.19	0.99
	277	24.09	27.31	0.10	0.88
L5	120	27.18	27.44	0.23	0.99
	277	28.93	32.00	0.12	0.90
L6	120	32.76	32.84	0.27	1.00
	277	34.09	36.72	0.13	0.93
L7	120	37.71	37.79	0.31	1.00
	277	38.86	41.77	0.15	0.93

# SD4DS / ICS432

4" SD LED Square Lensed Downlight - Wet Location

JOB NAME		CATALOG NUMBER	
NOTES		TYPE	

## SD4DSL1358 ICS432HZ-PR

### CCT MULTIPLIERS:

	<b>80 CRI</b>	<b>90 CRI</b>
2700K	(x 0.92)	(x 0.79)
3000K	(x 0.98)	(x 0.79)
3500K	(x 1.00)	(x 0.82)
4000K	(x 1.01)	(x 0.84)

### LENS MULTIPLIERS

	<b>30°</b>	<b>50°</b>	<b>70°</b>
CR	(x 1.00)	(x 1.00)	(x 1.00)
SB	(x 0.92)	(x 0.92)	(x 0.93)

### -NF (30° Narrow Flood)

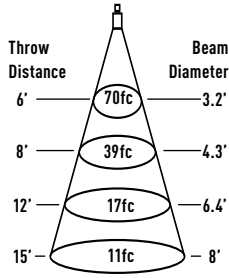

Footcandles at Nadir  
 Watts: 10      LPW: 87.5  
 Lumens: 875      CCT: 3500K

Luminance	
Degree	CBCP
0°	2507
5°	2326
15°	1282
25°	451
35°	117
45°	27

### -FL (50° Flood)

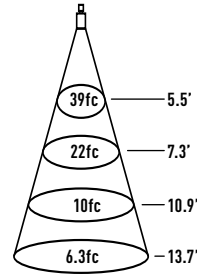

Footcandles at Nadir  
 Watts: 10      LPW: 94.9  
 Lumens: 949      CCT: 3500K

Luminance	
Degree	CBCP
0°	1410
5°	1400
15°	1228
25°	692
35°	181
45°	33

### -WF (70° Wide Flood)

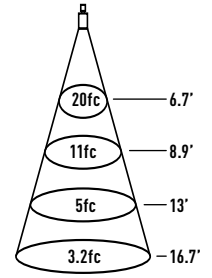

Footcandles at Nadir  
 Watts: 10      LPW: 75.2  
 Lumens: 752      CCT: 3500K

Luminance	
Degree	CBCP
0°	717
5°	710
15°	631
25°	476
35°	232
45°	81

## SD4DSL2358 ICS432HZ-PR

### CCT MULTIPLIERS:

	<b>80 CRI</b>	<b>90 CRI</b>
2700K	(x 0.92)	(x 0.79)
3000K	(x 0.98)	(x 0.79)
3500K	(x 1.00)	(x 0.82)
4000K	(x 1.01)	(x 0.84)

### LENS MULTIPLIERS

	<b>30°</b>	<b>50°</b>	<b>70°</b>
CR	(x 1.00)	(x 1.00)	(x 1.00)
SB	(x 0.92)	(x 0.92)	(x 0.93)

### -NF (30° Narrow Flood)

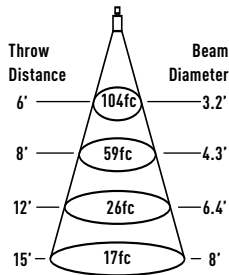

Footcandles at Nadir  
 Watts: 14      LPW: 93.7  
 Lumens: 1312      CCT: 3500K

Luminance	
Degree	CBCP
0°	3760
5°	3488
15°	1922
25°	677
35°	176
45°	41

### -FL (50° Flood)

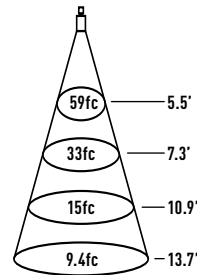

Footcandles at Nadir  
 Watts: 14      LPW: 101.6  
 Lumens: 1423      CCT: 3500K

Luminance	
Degree	CBCP
0°	2114
5°	2100
15°	1843
25°	1038
35°	272
45°	49

### -WF (70° Wide Flood)

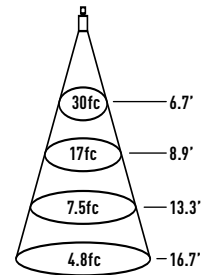

Footcandles at Nadir  
 Watts: 14      LPW: 80.5  
 Lumens: 1127      CCT: 3500K

Luminance	
Degree	CBCP
0°	1076
5°	1065
15°	946
25°	713
35°	348
45°	122

# SD4DS / ICS432

4" SD LED Square Lensed Downlight - Wet Location

JOB NAME		CATALOG NUMBER	
NOTES		TYPE	

## SD4DSL3358 IC432HZ-PR

### CCT MULTIPLIERS:

	80 CRI	90 CRI
2700K	(x 0.92)	(x 0.79)
3000K	(x 0.98)	(x 0.79)
3500K	(x 1.00)	(x 0.82)
4000K	(x 1.01)	(x 0.84)

### LENS MULTIPLIERS

	30°	50°	70°
CR	(x 1.00)	(x 1.00)	(x 1.00)
SB	(x 0.92)	(x 0.92)	(x 0.93)

### -NF (30° Narrow Flood)

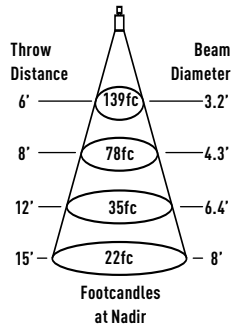

Watts: 19      LPW: 89  
Lumens: 1746      CCT: 3500K

Luminance	
Degree	CBCP
0°	5005
5°	4643
15°	2559
25°	901
35°	234
45°	54

### -FL (50° Flood)

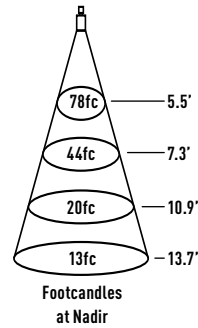

Watts: 19      LPW: 89  
Lumens: 1894      CCT: 3500K

Luminance	
Degree	CBCP
0°	2814
5°	2796
15°	2452
25°	1381
35°	362
45°	66

### -WF (70° Wide Flood)

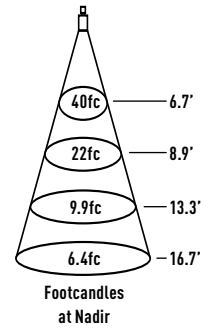

Watts: 19      LPW: 89  
Lumens: 1501      CCT: 3500K

Luminance	
Degree	CBCP
0°	1432
5°	1417
15°	1260
25°	949
35°	463
45°	163

## SD4DSL4358 IC432HZ-PR

### CCT MULTIPLIERS:

	80 CRI	90 CRI
2700K	(x 0.92)	(x 0.79)
3000K	(x 0.98)	(x 0.79)
3500K	(x 1.00)	(x 0.82)
4000K	(x 1.01)	(x 0.84)

### LENS MULTIPLIERS

	30°	50°	70°
CR	(x 1.00)	(x 1.00)	(x 1.00)
SB	(x 0.92)	(x 0.92)	(x 0.93)

### -NF (30° Narrow Flood)

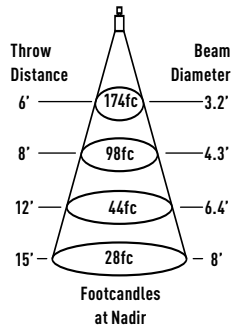

Watts: 23      LPW: 94.9  
Lumens: 2183      CCT: 3500K

Luminance	
Degree	CBCP
0°	6258
5°	5806
15°	3199
25°	1126
35°	293
45°	68

### -FL (50° Flood)

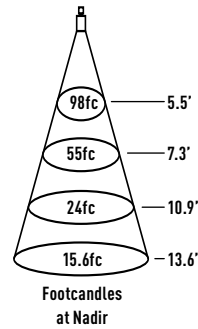

Watts: 23      LPW: 102.9  
Lumens: 2368      CCT: 3500K

Luminance	
Degree	CBCP
0°	3519
5°	3496
15°	3067
25°	1727
35°	452
45°	82

### -WF (70° Wide Flood)

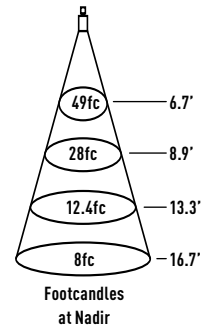

Watts: 23      LPW: 81.6  
Lumens: 1876      CCT: 3500K

Luminance	
Degree	CBCP
0°	1790
5°	1772
15°	1575
25°	1187
35°	580
45°	203