

# IVR15-SPI

1.5" Solid State Illuminated Rail

2" Post Integral Power Supply



JOB NAME		CATALOG NUMBER	
NOTES		TYPE	

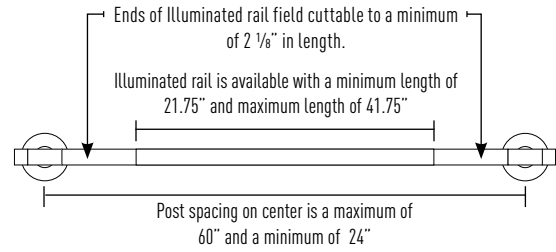
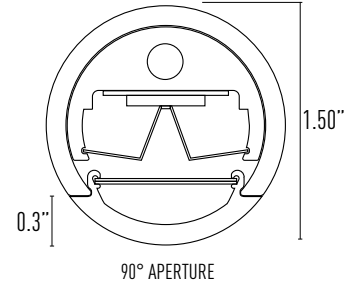

## PHOTOMETRIC DATA

- LED: 4.6W High Output
- CCT: 3500K
- Illuminated Rail Length: 41"
- Rail Height: 36"
- Post Spacing: 48"

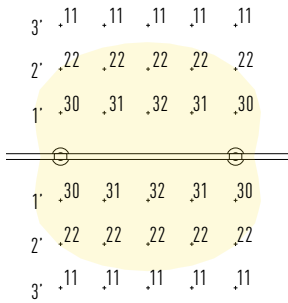

60° Flood

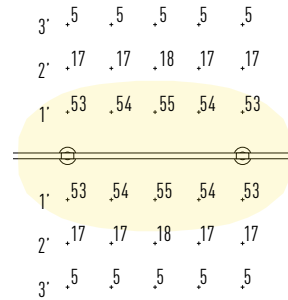

35° Narrow

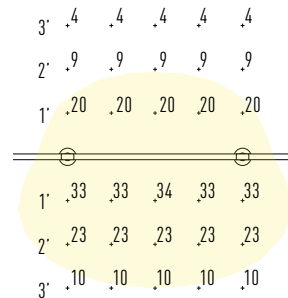

30° Asymmetrical

## CONSTRUCTION

**Internal Rail Construction:** Heavy duty extruded 6061-T6 Aluminum Alloy.

**External Rail Jacket:** Available in 304 or 316 stainless steel. Consult factory for custom powder coat finishes (AAMA 2604).

## LED LIGHT SOURCE

Closely packed array of small LEDs allow for smooth seamless illumination with immediate overlap to avoid pixilation and provide a continuous flow of light. Color temperatures options include 2700K, 3000K, 3500K or 4000K.

- 85 CRI
- 50,000 hours of average rated life at 70% output
- LED components are easily accessible to allow for easy maintenance
- Maximum run length per driver: 8'

## LED LIGHT ENGINE (PER FOOT)

- System Power Consumption: 4.6W
- Cool White 4000K: 219 lm
- Neutral White 3500K: 207 lm
- Warm White 3000K: 202 lm
- Warm White 2700K: 194 lm

## OPTICAL SYSTEM

Innovative optical system includes integral reflector and light shaping diffuser. 92% Transmission efficiency provides precise shaping, control and distribution of light. High-impact acrylic lens is secured with (2) countersunk flush screws, (1) at each end. Distributions include flood, narrow and asymmetric.

## MOUNTING / INSTALLATION

Each rail support is secured to the swivel mount on specified mounting system. Post or embedded mount is available. See mounting submittal sheets for detailed information.

## EMERGENCY

Remote emergency inverter available. Can be remote up to 1000 ft. available. See IB-IIS specification sheet.

## WARRANTY / LISTINGS

- 5-Year Intense LED Limited Warranty (LED & Power Supply Only)
- ETL Wet Location Listed
- IDA Approved
- ADA Compliant

## AWARD

- 2013 Next Generation Luminaires - "Recognized Winner"

# IVR15-SPI

## 2" Post Mount Assembly

JOB NAME		CATALOG NUMBER	
NOTES		TYPE	

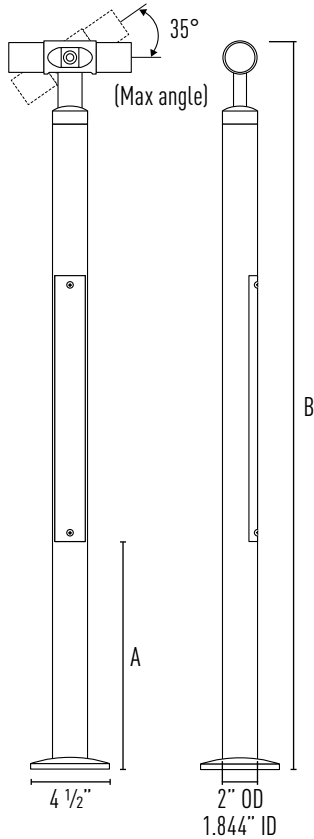

	Guardrail	Handrail
A	17"	14"
B	42"	36"

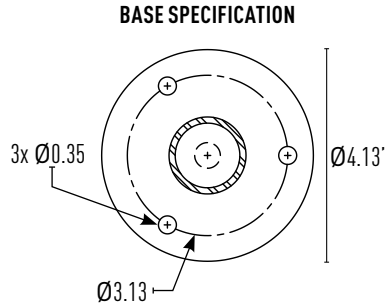

### CONSTRUCTION

Post mount assembly is available in No. 4 polished 304 stainless steel. Consult factory for custom powder coat finishes (AAMA 2604).

### MAINTENANCE

Posts include a driver access door where power supply components are easily accessible. Tamper proof hardware and special tools are standard and included.

### MOUNTING / INSTALLATION

Post are to be spaced at a maximum of 60" and minimum of 24" on centers. Post mount is to be surface mounted to concrete utilizing 3/8" anchor bolts (supplied by others). Anchoring means must be determined by local codes. Not to be supplied or engineered by Intense Lighting. See post mount installation chart for more information. Anchorage template available by request.

### OPERATION

Post with integral power supply will power up-to 83 1/2" of illuminated rail.

### FITTINGS

Consult factory for standard fittings and epoxy weld adhesive specification.

## Post Specification

## Post Mount Installation Detail

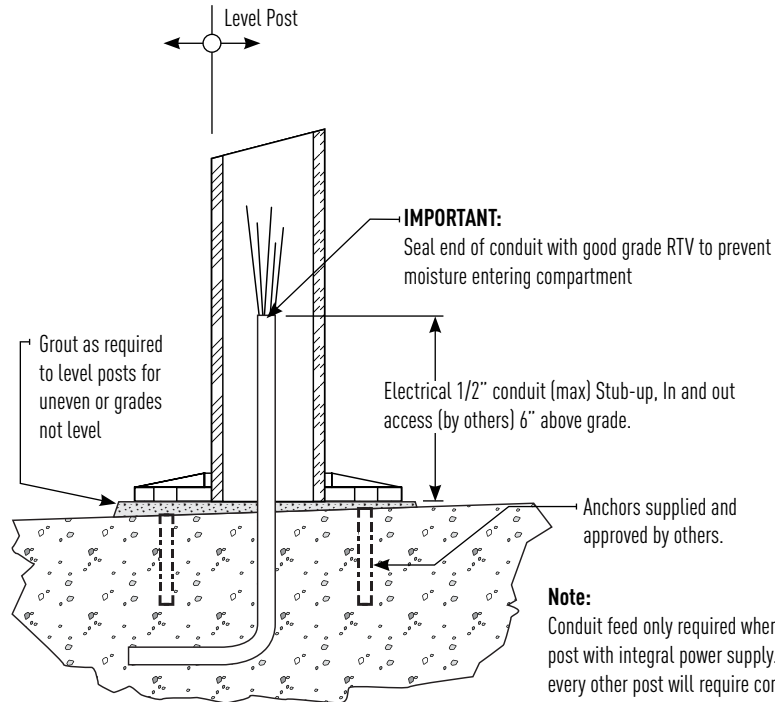
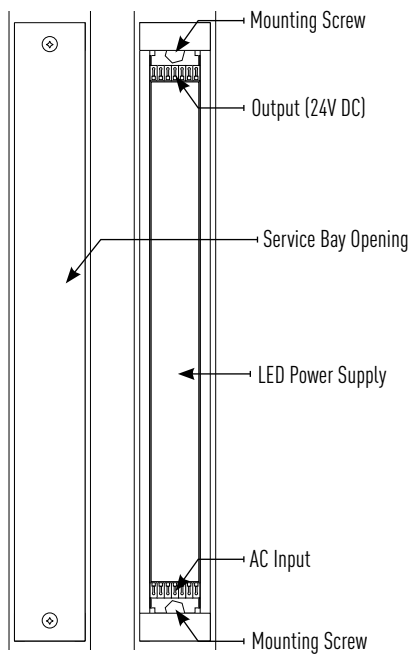

# IVR15-SPI

## 2" Post Embedded Assembly

JOB NAME		CATALOG NUMBER	
NOTES		TYPE	

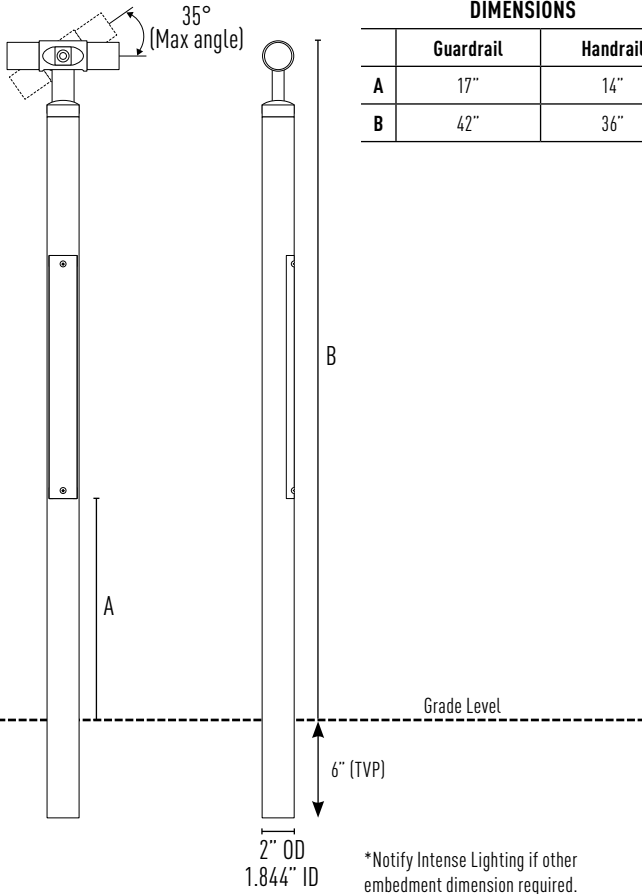

	Guardrail	Handrail
A	17"	14"
B	42"	36"

\*Notify Intense Lighting if other embedment dimension required.

### CONSTRUCTION

Post mount assembly is available in No.4 polished 304 stainless steel. Consult factory for custom powder coat finishes (AAMA 2604).

### MAINTENANCE

Posts include a driver access door where power supply components are easily accessible. Tamper proof hardware and special tools are standard and included.

### MOUNTING / INSTALLATION

Post are to be spaced at a maximum of 60" and minimum of 24" on centers. Embedded mount post are set into place using Rockite® or Kwixset® anchor cement. A minimum of 6" post must be embedded into concrete to structurally secure post. Anchoring means must be determined by local codes. Not to be supplied or engineered by Intense Lighting. See Embedded Mount Installation chart for more information.

### OPERATION

Post with integral power supply will power up-to 83 1/2" of illuminated rail.

### FITTINGS

Consult factory for standard fittings and epoxy weld adhesive specification.

## Post Specification

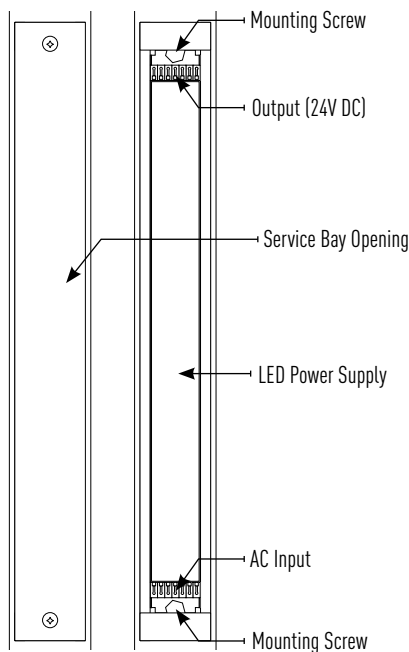

## Embedded Installation Detail

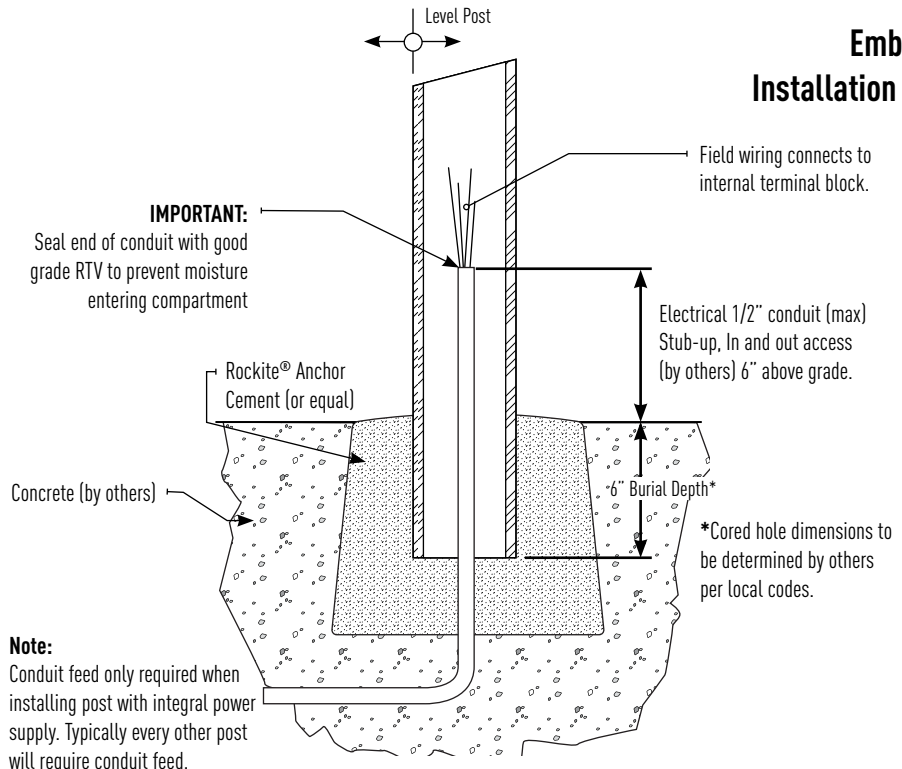

# IVR15-SPI

## 1.5" Solid State Illuminated Rail Specification Guide

<b>JOB NAME</b>		<b>CATALOG NUMBER</b>	
<b>NOTES</b>		<b>TYPE</b>	

**V-Rail Part Number (Example: IVR15-SPI-ST-P36-H027-60S)**  
(Specify Quantity By Foot)

A: Family	B: Finish	C: Mounting/Height	D: LED Output	E: CCT	F: Light Distribution	G: Electrical	H: Options
<b>IVR15-SPI</b>	<b>-ST</b> (304 Stainless Steel) <sup>1</sup> <b>-C</b> (Custom) <sup>2</sup>	<b>-P36</b> (36" Post Mount) <b>-P42</b> (42" Post Mount) <b>-E36</b> (36" Embedded Mount) <b>-E42</b> (42" Embedded Mount)	<b>-HO</b> (High Output 4.6W)	<b>27</b> (2700K) <b>30</b> (3000K) <b>35</b> (3500K) <b>40</b> (4000K)	<b>-60S</b> (60° Flood) <b>-35S</b> (35° Narrow) <b>-30AS</b> (30° Asymmetric)	blank ERP VLM Series 120/277V Input Driver <b>-LUT2</b> Lutron LTEA 2-Wire 1% Dim 120V Input Driver	<b>-I</b> (Infill) <sup>2</sup>

**Notes:**

1. 316 Stainless steel available by special order
2. Special order, consult factory
3. No LED (rail only), see IVR15-RPS

### Specification and Delivery Process

Architectural drawings or detailed elevation drawings are required for a V-Rail quotation. Once an order is placed, Intense Lighting will provide detailed shop drawings for approval.

V-Rail will be delivered to the job site ready for installation. A detailed assembly drawing will be provided along with dimensions and locations for remote power supplies. All products included will be labeled clearly to match the assembly drawing. Certain tools and equipment will be required for the assembly of V-Rail. A detailed list of tools can be found in the V-Rail Installation Guide. Installation guide available upon request, consult factory.

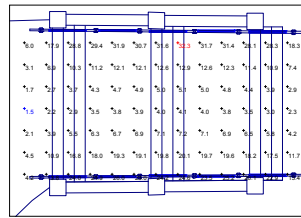

*Photometric Layout*

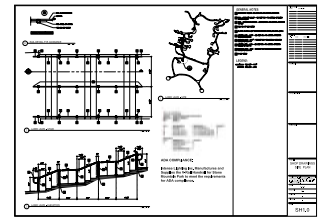

*Shop Drawing / Assembly Guide*



*Completed Project*

**Notes:**