

IVR2-RPS

1.9" Solid State Illuminated Rail

Remote Power Supply

JOB NAME		CATALOG NUMBER	
NOTES		TYPE	



U.S. Patent # D615,217S issued
Other patents pending

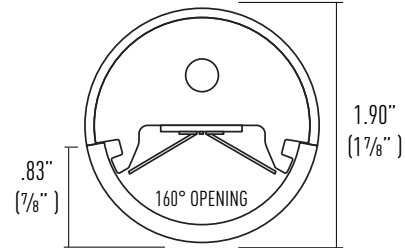

Exact decimal and common fraction is shown

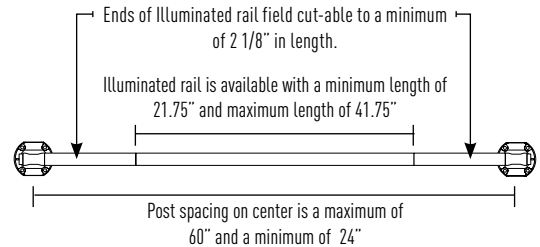

PHOTOMETRIC DATA

- LED: 4.6W High Output
- CCT: 4000K
- Illuminated Rail Length: 41"
- Rail Height: 36"
- Post Spacing: 48"

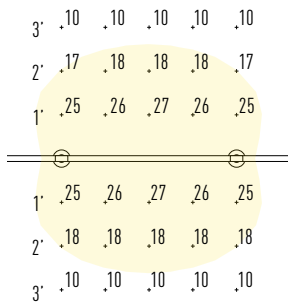

60° Flood

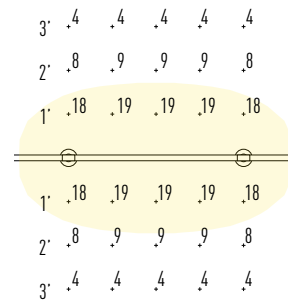

20° Narrow

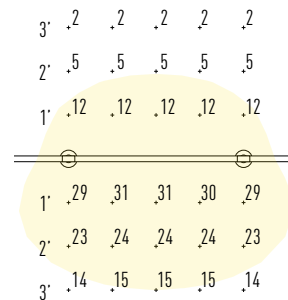

30° Asymmetrical

CONSTRUCTION

Internal Rail Construction: Heavy duty extruded 6061-T6 Aluminum Alloy.

External Rail Jacket: Available in 304 or 316 stainless steel. Optional color finishes include silver, white, black, or bronze powder-coat. Consult factory for custom powder coat finishes (AAMA 2604).

LED LIGHT SOURCE

Closely packed array of small LEDs allow for smooth seamless illumination with immediate overlap to avoid pixilation and provide a continuous flow of light. Color temperatures options include 2700K, 3000K, 3500K or 4000K.

- 85 CRI
- 50,000 hours of average rated life at 70% output

LED LIGHT ENGINE (PER FOOT)

High Output

- System Power Consumption: 4.6W
- Cool White 4000K: 241 lm
- Neutral White 3500K: 207 lm
- Warm White 3000K: 202 lm
- Warm White 2700K: 197 lm

Super High Output

- System Power Consumption: 9.2W
- Cool White 4000K: 483 lm
- Neutral White 3500K: 415 lm
- Warm White 3000K: 404 lm
- Warm White 2700K: 395 lm

LIGHT DISTRIBUTION & OUTPUT

The V-Rail optical system includes a unique reflector that allows you to put the light where it is needed. Factory preset distributions include 60° symmetric, 20° symmetric and 30° asymmetric.

OPTICAL LENS SYSTEM

High-impact acrylic lens is sealed with silicone. Lens is secured with (2) countersunk flush screws, (1) at each end. Vandal resistant "TORX" is also available. Consult factory.

REFLECTOR SYSTEM

Internal reflector system is constructed of an innovative material that has 99% reflectance properties. Reflector allows up to 140° total adjustment. Right to left side reflector panels are independently adjustable from -30° to 70°. When the outer reflector panel is adjusted toward a stairway, ramp or walkway, the reflector panel will act as a glare shield from distant viewing angles below an elevated platform.

REMOTE MOUNTING POWER SUPPLY

Configured per project requirements. Supplies 24V electronically stabilized power to LED's. U.L. Class 2 output for safe operation. Housed to NEMA rated enclosures. Intense Lighting provides shop drawings and specification to satisfy Architect and Electrical Contractor.

MOUNTING / INSTALLATION

Each rail support is secured to the swivel mount on specified mounting system. Wall, post or embedded mount is available. See mounting submittal sheets for detailed information.

EMERGENCY

Remote emergency inverter available. Can be remote up to 1000 ft. See IB-IIS specification sheet.

LISTINGS

- 5-Year Intense LED Limited Warranty (LED & Power Supply Only)
- UL Wet Location Listed. File #E333075
- IDA approved
- ADA compliant

IVR2-RPS

2" Remote Post Mount Assembly

JOB NAME		CATALOG NUMBER	
NOTES		TYPE	

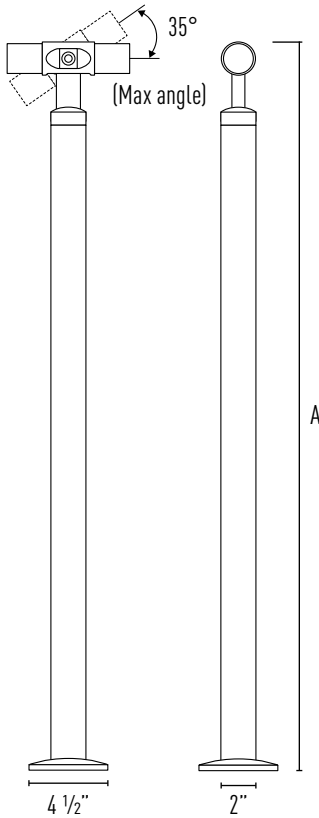

DIMENSIONS		
	Guardrail	Handrail
A	42"	36"

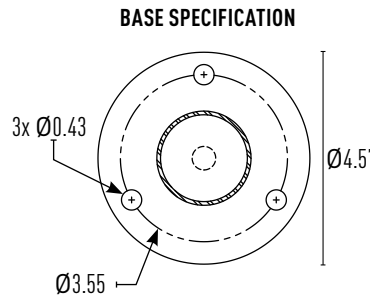

CONSTRUCTION

Post mount assembly is available in heavy duty steel alloy or No.4 polished 304 stainless steel. Optional color finishes include silver, white, black, or bronze powder-coat. Consult factory for custom powder coat finishes (AAMA 2604).

MOUNTING / INSTALLATION

Post are to be spaced at a maximum of 60" and minimum of 24" on centers. Post mount is to be surface mounted to concrete utilizing 5/16" anchor bolts (supplied by others). Anchoring means and size must be determined by local codes. Not to be supplied or engineered by Intense Lighting. See post mount installation chart for more information. Anchorage template available by request.

FITTINGS

Consult factory for standard fittings and epoxy weld adhesive.

Post Mount Installation Detail

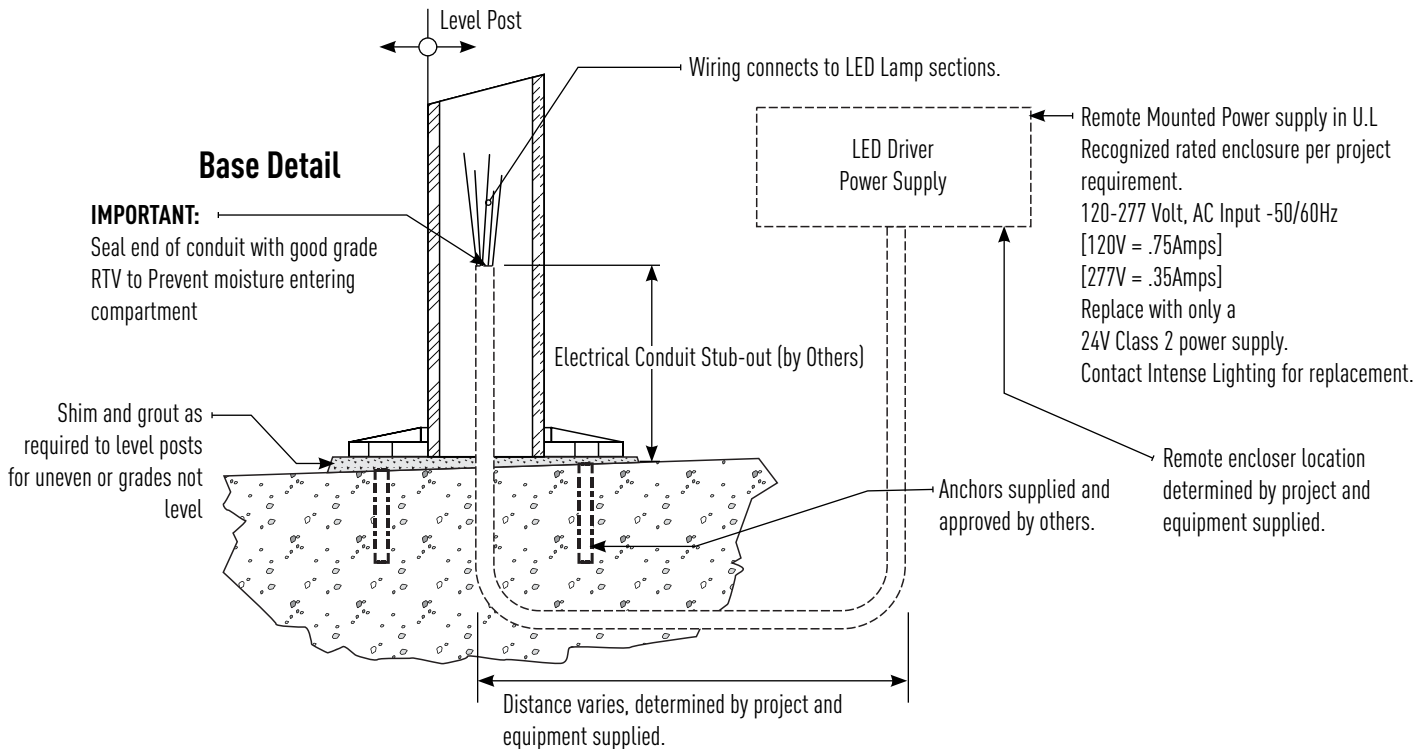

IVR2-RPS

2" Remote Post Embedded Assembly

JOB NAME		CATALOG NUMBER	
NOTES		TYPE	

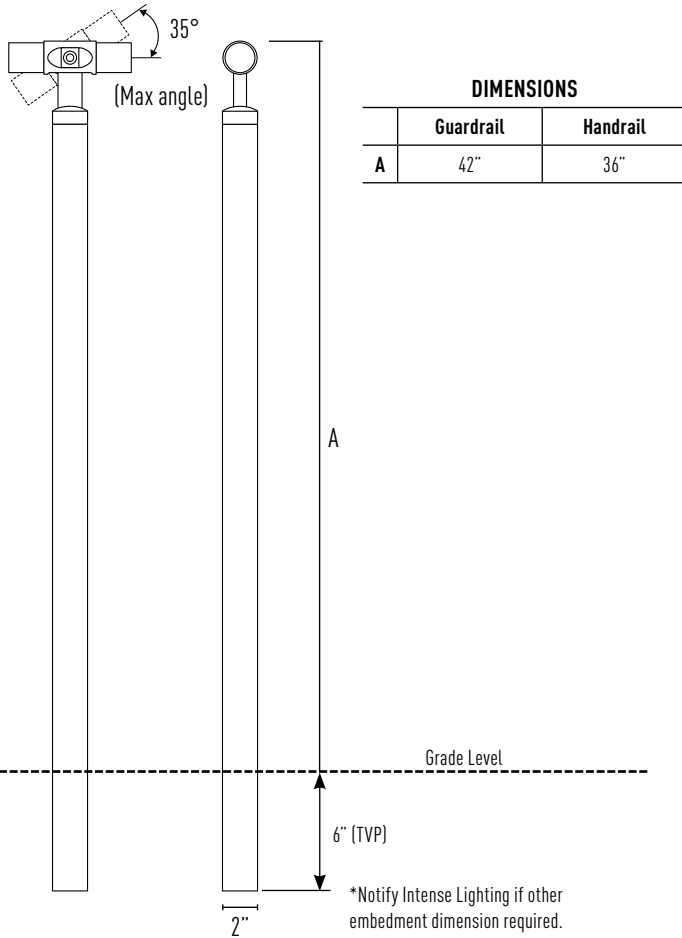

CONSTRUCTION

Embedded mount assembly is available in heavy duty steel alloy or No.4 polished 304 stainless steel. Optional color finishes include silver, white, black, or bronze powder-coat. Consult factory for custom powdercoat finishes(AAMA 2604).

MOUNTING / INSTALLATION

Post are to be spaced at a maximum of 60" and minimum of 24" on centers. Embedded mount post are set into place using Rockite® or Kwixset® anchor cement. A minimum of 6" post must be embedded into concrete to structurally secure post. Anchoring means and size must be determined by local codes. Not to be supplied or engineered by Intense Lighting. See Embedded Mount Installation chart for more information.

FITTINGS

Consult factory for standard fittings and epoxy weld adhesive.

Embedment Installation Detail

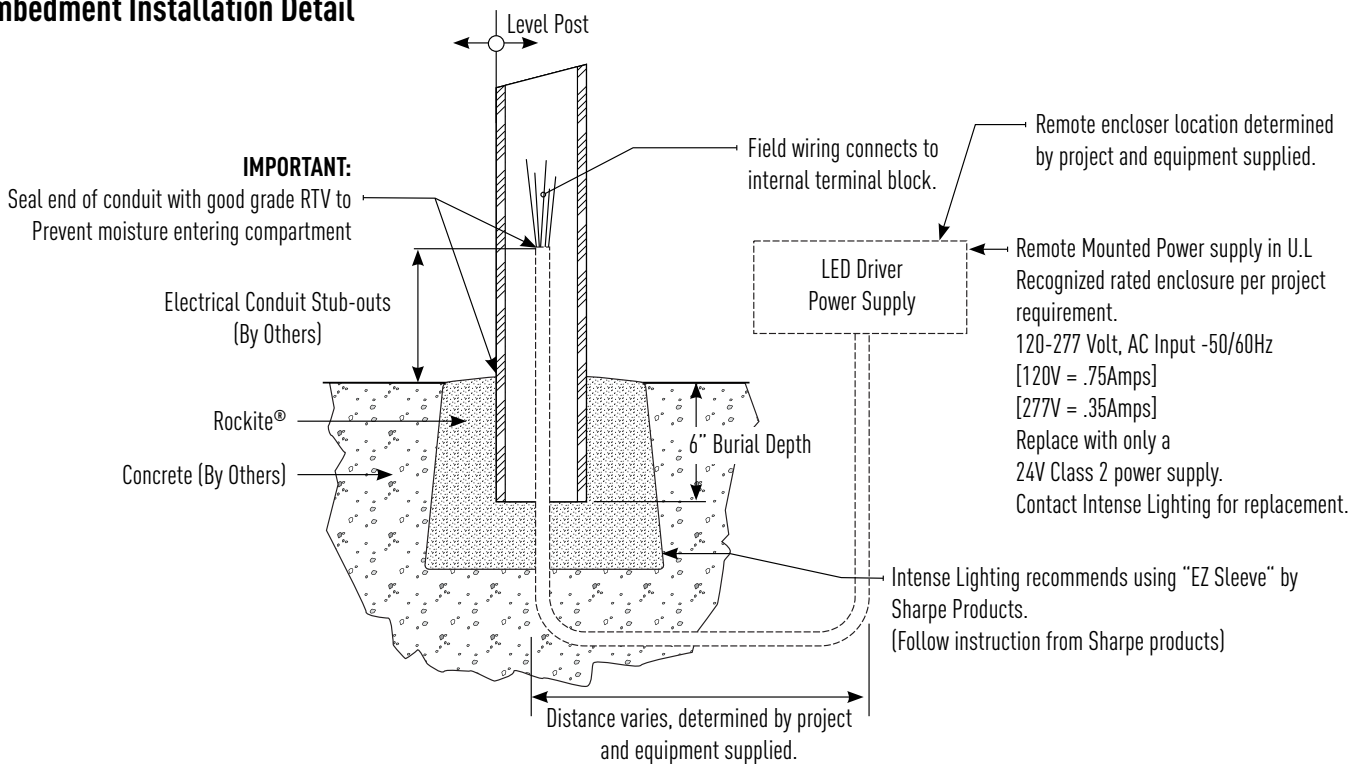

V-RAIL U/M-041624-P-3

INTENSE LIGHTING | 3340 E La Palma Ave, Anaheim, CA 92806 | tel 714 630-9877 | fax 714 630-9883

For Intense Lighting's limited product warranty, go to www.intenselighting.com. For a printed copy of the warranty, you may call 800 961-5321.

© 2024 Intense Lighting, LLC. All rights reserved. Note: This document is subject to change without notice.

IVR2-RPS

2" Remote Post Wall Mount Assembly

JOB NAME		CATALOG NUMBER	
NOTES		TYPE	

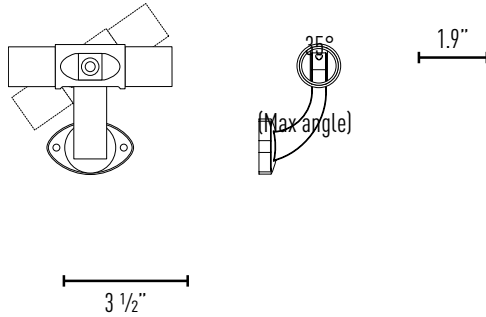

CONSTRUCTION

Wall mount assembly is available in heavy duty aluminum or No.4 polished 304 stainless steel. Optional color finishes include silver, white, black, or bronze powder-coat. Consult factory for custom powdercoat finishes.

MOUNTING / INSTALLATION

Post are to be spaced at a maximum of 60" and minimum of 24" on centers. Wall mount assembly is to be mounted to concrete wall utilizing 1/4" anchor bolts (supplied by others). Anchoring means and size must be determined by local codes. Not to be supplied or engineered by Intense Lighting. See Wall Mount Installation chart for more information. Anchorage template available by request.

FITTINGS

Consult factory for standard fittings and epoxy weld adhesive.

WALL BRACKET SPECIFICATION

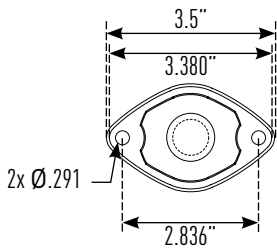

Wall Mounted Installation Detail

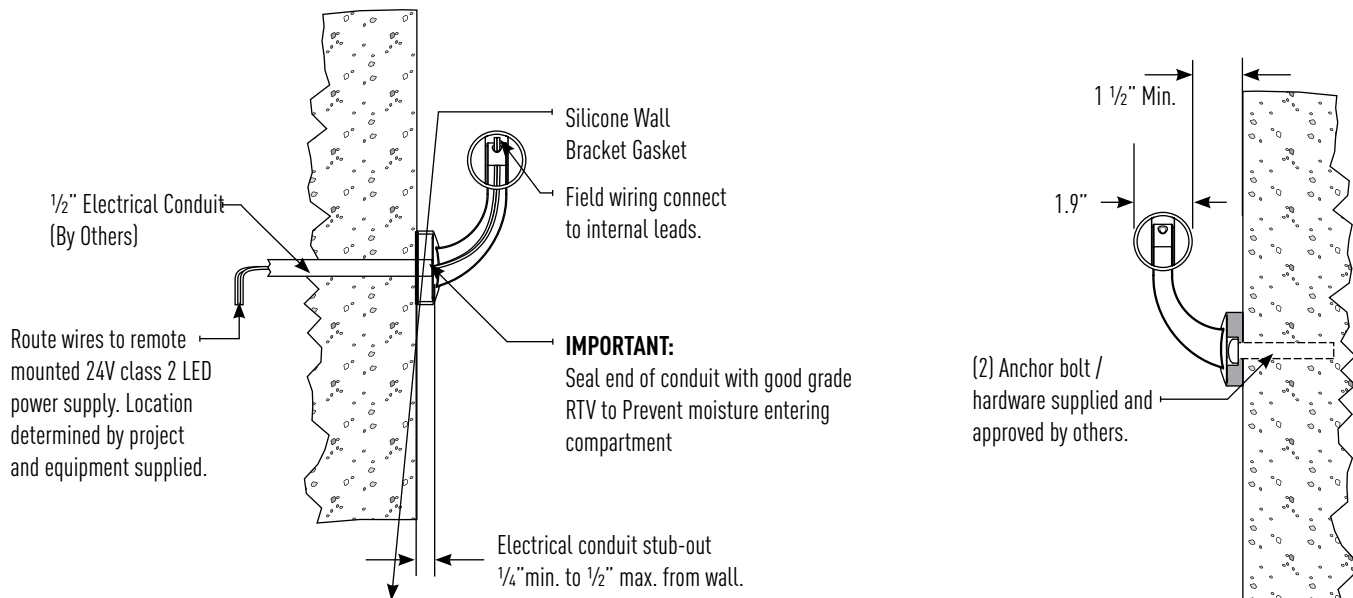

IVR2-RPS

Remote Power Supply

Wet Location No Enclosure Required

JOB NAME		CATALOG NUMBER	
NOTES		TYPE	

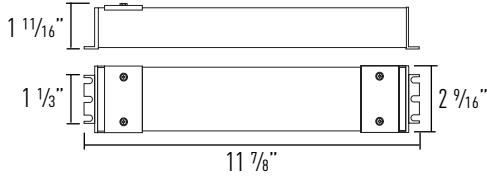

IB-OT96 - 96W 24V Damp Location

IB-OT96-DIM - 96W 24V Damp Location 0-10V Dimming

FEATURES

- Protected against open circuit, short circuit, overload and overheating issues
- Universal 120-277V input
- UL Wet location listed and FCC compliant
- Built in wiring compartments
- Integrated 0-10V dimming available

MAX RUN LENGTH (POST ON 4' CENTER)

- High Output (HO) - 20'

SPECIFICATIONS

- Input: 100-240VAC, 1.5-0.75A
277VAC / 0.47A, 47-63Hz
- Output: 96W 24V / 4A
- Ambient Temperature Range: -22°F to 158°F (-30°C to 70°C)
- Weight: 2 lbs (.09 kg)
- Wiring: 18 AWG
- Classification: Class 2
- Protection Rating: IP66
- UL/cUL Recognized for damp location

Maximum Mounting Distance (ft) to LED Input (at full load)

Power Supply	22 AWG	18 AWG	14 AWG	12 AWG
IB-OT96	7'	18'	46'	71'
IB-ADV24V-347	7'	18'	46'	71'

Remote Wiring Limitation for Constant Voltage Power Supplies Due to EMI

All Constant Current power supplies are limited to **32ft maximum** remote mounting distance for EMI compliance (except NAED 51524 OT3/120-240/350 – 50ft).

Although it is possible to exceed the EMI limited remote mounting distance, it is the responsibility of the installer and/or end user to take precautions to prevent and/or test the effects of EMI on the installation. Additional EMC/EMI filters may be required on the output side of the power supply for compliance of installations above the limits given in Table 1.

IVR2-RPS

Remote Power Supply

Multiple Output Wet Location Enclosure

Nema 4x UL Listed Outdoor Rated PVC Boxes

Non-Corroding, Non-Conducting, Fire Resistant, Concrete Tight



Suitable for Surface Mount and Recessed Mount

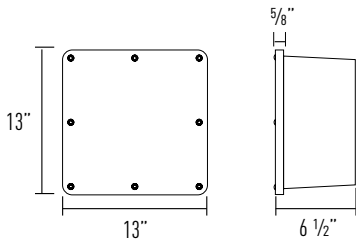

LED Remote Power Supply "No Dimming"

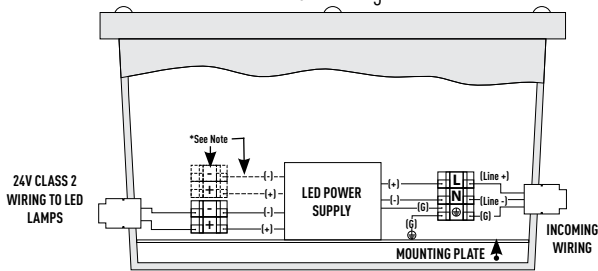

LED Remote Power Supply "With Dimming"

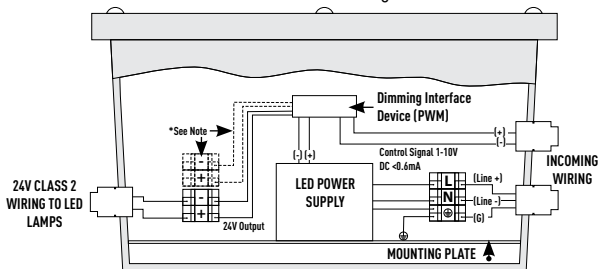

Wire gauge to be determined per project. Voltage drop occurs with distance. Any change in wire length requires re-engineering.

*Notes: Dash lines represent additional outputs when supplied per project.

All components inside enclosure are supplied by Intense Lighting.

JOB NAME	CATALOG NUMBER
NOTES	TYPE

IVR-RPS-1-0T96 - (1) 96W 120/277V (1) 24V Outputs

IVR-RPS-2-0T96 - (2) 96W 120/277V (2) 24V Outputs

IVR-RPS-3-0T96 - (3) 96W 120/277V (3) 24V Outputs

FEATURES

- Protected against open circuit, short circuit, overload and overheating issues
- Universal 120-277V input
- Suitable for damp and wet locations
- Easy connectivity to terminal blocks
- Integrated 0-10V dimming available

SPECIFICATIONS

- Input Power: 108-305VAC, 50/60 Hz, .91A @ 120VAC
- Output Power: 96W 24V DC
- Ambient Temperature Range: -22°F to 158°F (-30°C to 70°C)
- Classification: Class 2
- Protection Rating: IP66

IVR-RPS-1-ADV24V-347 - (1) 96W 347V (1) 24V Outputs

IVR-RPS-2-ADV24V-347 - (2) 96W 347V (2) 24V Outputs

IVR-RPS-3-ADV24V-347 - (3) 96W 347V (3) 24V Outputs

FEATURES

- Protected against open circuit, short circuit, overload and overheating issues
- Ideal for projects in USA with 480V input
- Ideal for projects in Canada with 347V input

SPECIFICATIONS

- Input Power: 347-480VAC,
- Output Power: 100W 24V DC
- Ambient Temperature Range: -40°C to 65°C
- Classification: Class 2
- Protection Rating: IP66

IVR2-RPS

V-Rail Remote Power Supply Specification Guide

JOB NAME		CATALOG NUMBER	
NOTES		TYPE	

V-Rail Part Number (Example: IVR2-RPS-ST-W-SHO27-60S)

(Specify Quantity By Foot)

A: Family	B: Finish	C: Mounting/Height	D: LED Output	E: CCT	F: Light Distribution	G: Electrical	H: Options
IVR2-RPS	-ST (304 Stainless Steel) ¹ -W (White) -B (Black) -BR (Bronze) -SV (Silver) -C (Custom) ²	-W (Wall Mount) -P36 (36" Post Mount) -P42 (42" Post Mount) -E36 (36" Embedded Mount) -E42 (42" Embedded Mount)	-HO (High Output) -SHO (Super High Output) -NL (No LED - Rail Only) ³	27 (2700K) 30 (3000K) 35 (3500K) 40 (4000K)	-60S (60° Symmetric) -20S (20° Symmetric) -30AS (30° Asymmetric)	blank (24V Input)	-I (Infill) ²

Notes:

- 316 Stainless steel available by special order
- Special order, consult factory
- No LED (rail only). Please omit sections E, F, and G

Specification and Delivery Process

Architectural drawings or detailed elevation drawings are required for a V-Rail quotation. Once an order is placed, Intense Lighting will provide detailed shop drawings for approval.

V-Rail will be delivered to the job site ready for installation. A detailed assembly drawing will be provided along with dimensions and locations for remote power supplies. All products included will be labeled clearly to match the assembly drawing. Certain tools and equipment will be required for the assembly of V-Rail. A detailed list of tools can be found in the V-Rail Installation Guide. Installation guide available upon request, consult factory.

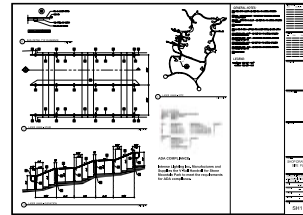

Shop Drawing / Assembly Guide



Completed Project

Notes: