

XS2 / XS2T-DRT202

2" XS LED Downlight

JOB NAME		CATALOG NUMBER	
NOTES		TYPE	

ELECTRICAL DATA

LED Light Engine	Nominal Delivered Lumens*	System Wattage**
L1	700lm @ 3000K / 82 CRI	10 Watts
L2	1100lm @ 3000K / 82 CRI	15 Watts

* Delivered lumens will vary depending on CCT, CRI, optic and finish.

** System Wattage include driver and LED Module consumption.

FEATURES

- Single modular platform
- 2 Step MacAdam Ellipse binning (2 SDCM) ensures color consistency across luminaires
- Die-cast aluminum trims in architectural grade finishes
- Interchangeable round and square trims
- Field changeable TIR optics in 18°, 24° & 36°

LED LIGHT ENGINE

- High quality LED with 2 SDCM binning
- 82 CRI in 2700K, 3000K, 3500K or 4000K
- 92 CRI in 2700K
- 50,000 hours L70 (rated life at 70% output)

ELECTRICAL SYSTEM

- 0-10V 1% or ELV reverse/forward phase dimming
- 120V or 277V input; Power factor >.9, 50/60Hz
- This product complies with IEEE C62.41 for surge endurance up to 2.5KV. Additional surge protection recommended. Damage from power surge is not covered by warranty.

DIMMING

- Forward/Reverse phase and 0-10V dimming options available via single driver option
- Forward/ reverse phase dimming -120V only
- 0-10V 1% dimming

HOUSING

- Remodel style housing made from 20 gauge zinc plated cold rolled steel
- Standard 1/2" collar accommodates up to 1" ceiling thickness
- Extended collar options available for field installation up to 2-inch ceiling thickness
- For new construction, plaster frame XS2-NCFR (see below for details) is recommended

TRIM ASSEMBLY

- High quality die-cast aluminum trim with durable powder coat available in multiple finishes

INSTALLATION

Housing types include IC Air-Tight or Non-IC Rated (must specify). Non-IC rated housings must be kept at a minimum of 3" away from insulation.

LISTING

- Driver Assembly: ETL listed to US and Canadian standards for damp location
- Trim Assembly: ETL listed to US and Canadian standards for wet location
- (-IC Only) ETL listed for direct contact w/insulation
- 5-Year Intense LED Limited Warranty
- Can be used to comply with 2016 Title 24-Part 6 High Efficacy LED Light Source Requirements

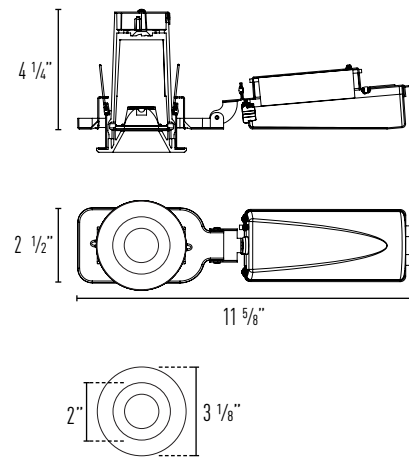

Ceiling Cut Out: 2 1/16" (Round Diameter)

Driver Assembly Part Number (Example: XS2-NCL1)

Driver Assembly	Installation Type	Wattage	Dimming	Voltage
XS2	-NC (Non-IC)	L1 (10 Watts)	blank (Phase / 0-10V) ²	blank (120V)
	-IC (Air-Tight IC)	L2 (15 Watts) ¹		27 ² (277V)

Trim Assembly Part Number (Example: XS2T-DRT202W-SF30NF)

Trim Assembly	Trim Finish	CCT / CRI	Optic
XS2T-DRT202	W-SF (White / Self Flanged)	27 (2700K / 82 CRI)	SP (18° Spot)
	B-SF (Black / Self Flanged)	279 (2700K / 92 CRI)	NF (24° Narrow Flood)
	AB-SF (Antique Bronze / Self Flanged)	30 (3000K / 82 CRI)	FL (36° Flood)
	W-NC (White / Non-Conductive)	35 (3500K / 82 CRI)	
		40 (4100K / 82 CRI)	

Notes:

- L2 lumen package available in Non-IC only
- 277V not available with phase dimming
- Excludes: 82 CRI Options

Accessories (Must be ordered separately)

- XS2-NCFR** New construction flat frame w/bar hangers
- XS2-EC1** Extended collar for thick ceiling 1 - 1 1/2"
- XS2-EC2** Extended collar for thick ceiling 1 1/2" - 2"

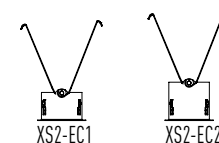
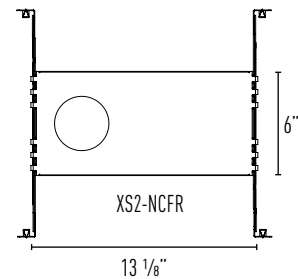

XS-DOWNLIGHTING LUM-092123 P-1

INTENSE LIGHTING | 3340 E La Palma Ave, Anaheim, CA 92806 | tel 714 630-9877 | fax 714 630-9883

For Intense Lighting's limited product warranty, go to www.intenselighting.com. For a printed copy of the warranty, you may call 800 961-5321.

© 2023 Intense Lighting, LLC. All rights reserved. Note: This document is subject to change without notice.

XS2 / XS2T-DRT202

2" XS LED Downlight

JOB NAME		CATALOG NUMBER	
NOTES		TYPE	

XS2-NCL1 / XS2T-DRT202W-SF30

Report #: ILL-20170508-05 (SP)
ILL-20170508-06 (NF)
ILL-20170505-02 (FL)

CCT / CRI Multipliers:

2700K / 82 CRI (x 0.93)
2700K / 92 CRI (x 0.75)
3000K / 82 CRI (x 1.00)
3500K / 82 CRI (x 1.00)
4000K / 82 CRI (x 1.00)

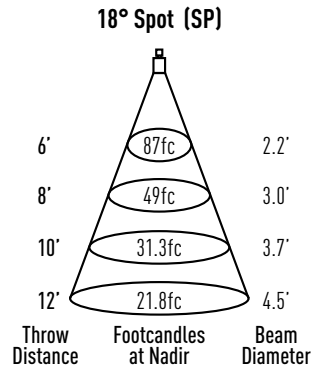

Watts: 10
Lumens: 677
LPW: 68
CCT: 3000K

Candelas at Nadir

Degree	CBCP
0°	3133
5°	2724
15°	722
25°	215
35°	131
45°	19

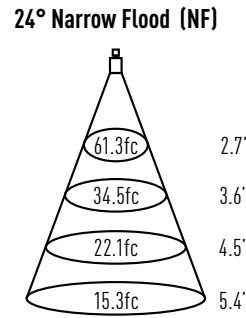

Watts: 10
Lumens: 668
LPW: 67
CCT: 3000K

Candelas at Nadir

Degree	CBCP
0°	2208
5°	1985
15°	843
25°	247
35°	128
45°	21

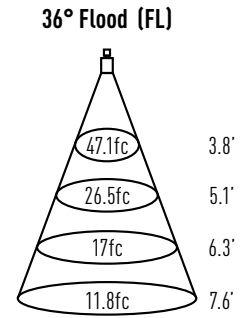

Watts: 10
Lumens: 731
LPW: 73
CCT: 3000K

Candelas at Nadir

Degree	CBCP
0°	1697
5°	1599
15°	1017
25°	393
35°	98
45°	15

XS2-NCL2 / XS2T-DRT202W-SF30

Report #: ILL-20170509-04.01 (SP)
ILL-20170509-01.01 (NF)
ILL-20170505-01.01 (FL)

CCT / CRI Multipliers:

2700K / 82 CRI (x 0.93)
2700K / 92 CRI (x 0.75)
3000K / 82 CRI (x 1.00)
3500K / 82 CRI (x 1.00)
4000K / 82 CRI (x 1.00)

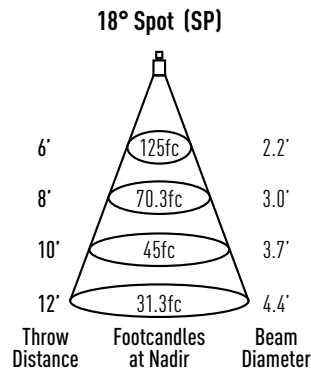

Watts: 15.1
Lumens: 967
LPW: 64
CCT: 3000K

Candelas at Nadir

Degree	CBCP
0°	4500
5°	3924
15°	1030
25°	304
35°	186
45°	26

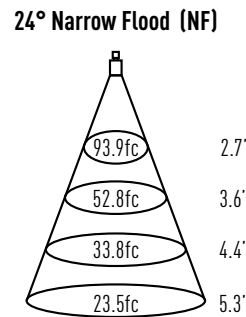

Watts: 15.1
Lumens: 1017
LPW: 67
CCT: 3000K

Candelas at Nadir

Degree	CBCP
0°	3380
5°	3024
15°	1279
25°	377
35°	197
45°	32

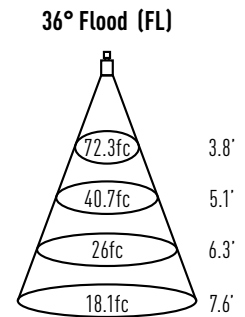

Watts: 15.1
Lumens: 1114
LPW: 74
CCT: 3000K

Candelas at Nadir

Degree	CBCP
0°	2604
5°	2457
15°	1556
25°	596
35°	148
45°	22